



CATALOGUE
RANGEMENT



www.idequip.com

Bac à bec Storage bins P.3

Bac à bec	Storage bin	P.4
Bac à monter	Self-assembly bin	P.6
Bac tiroir	Drawer bin	P.7
Rayonnage pour bac	Storage cupboard for bins	P.8

Bac de manutention Storage crates P.11

Bac picking	Picking crate	P.12
Bac norme Europe	Euronorm crate	P.13
Bac pliant	Foldable crate	P.14
Bac navette	Nestable crate	P.17

Coffre et malle Trunk & chest P.19

Coffre industriel	Industrial chest	P.20
Malle multifonction	Multifunction chest	P.22
Malle aluminium	Aluminum chest	P.24

Mallette de protection Protection case P.27

Mallette étanche	Waterproof case	P.28
Mallette de rangement	Storage case	P.30
Mallette aluminium	Aluminum case	P.31
Mallette de présentation	Packaging case	P.32

Boîte et mallette de rangement Storage box & case P.35

Casier de rangement	Storage cabinet	P.36
Mallette à godets	Case with inserts	P.38
Mallette avec séparateurs	Case with dividers	P.40

Rangement outillage Tool storage P.43

Panneau d'atelier	Tool wall panel	P.44
Rangement outils tissu	Soft tool storage	P.45
Boîte à outils	Toolbox	P.46

Manutention Handling P.49

Chariot industriel	Industrial trolley	P.50
Diable de manutention	Handling truck	P.56
Coins roulants	Rolling corners	P.58
Caisse pliante	Foldable crate	P.58
Servante	Double tray trolley	P.59
Chariot courrier	Mail trolley	P.60
Dévidoir	Dispenser	P.61

SPACY



BAC À BEC SUPERPOSABLE / EMBOITABLE À VIDE

Bacs à bec fabriqués en polypropylène. Ils permettent de ranger et classer les fournitures et petites pièces. Superposables entre eux et emboîtables à vide, ils peuvent être posés également sur des étagères ou accrochés sur un rail en métal vendu séparément (pour SPACY 2 et 3). Ils sont équipés d'un porte-étiquette (étiquette non fournie). Qualité alimentaire.

NESTABLE & STACKABLE STORAGE BIN

Storage bins made of polypropylene. You can easily introduce the hand in the bin to pick up the stored products. Each bin has a label holder (delivery without label) to identify the contents. Can be stacked on the top of each other and nestable when empty. They can be placed in a cupboard or onto shelves. An aluminium back frame is available as option (RAIL). Food approved.



RAIL ACIER (Pour SPACY 2 et 3)
STEEL RAIL (For SPACY 2 and 3)



Emboîtable à vide
Nestable when empty



Code		Litre	P x l x H EXT mm		Kg
SPACY 2 B		1 L	157 x 101 x 70	24	0,06
SPACY 3 B		4 L	235 x 150 x 126	24	0,205
SPACY 4 B		10 L	335 x 215 x 150	24	0,436
SPACY 5 B		28 L	455 x 300 x 175	8	0,89
SPACY 2 R		1 L	157 x 101 x 70	24	0,06
SPACY 3 R		4 L	235 x 150 x 126	24	0,205
SPACY 4 R		10 L	335 x 215 x 150	24	0,436
SPACY 5 R		28 L	455 x 300 x 175	8	0,89
RAIL		-	500 x 60	10	0,18

Livré sans étiquette / Delivery without label

STAR



BAC À BEC PROFESSIONNEL GRANDE OUVERTURE

Fabriqués en polypropylène, les bacs à bec STAR sont de qualité alimentaire. Design évolué et avec une grande ouverture facilitant l'accès au contenu, ils s'adapteront parfaitement aux missions de rangement et stockage. Superposables, tous disposent d'un porte étiquette (étiquette non fournie).

PROFESSIONAL STORAGE BIN LARGE OPENING

STAR storage bins have a modern design and are manufactured with a large opening. They are stackable. Made of a food approved polypropylene, each bin has a label holder (delivery without label) to identify the contents.

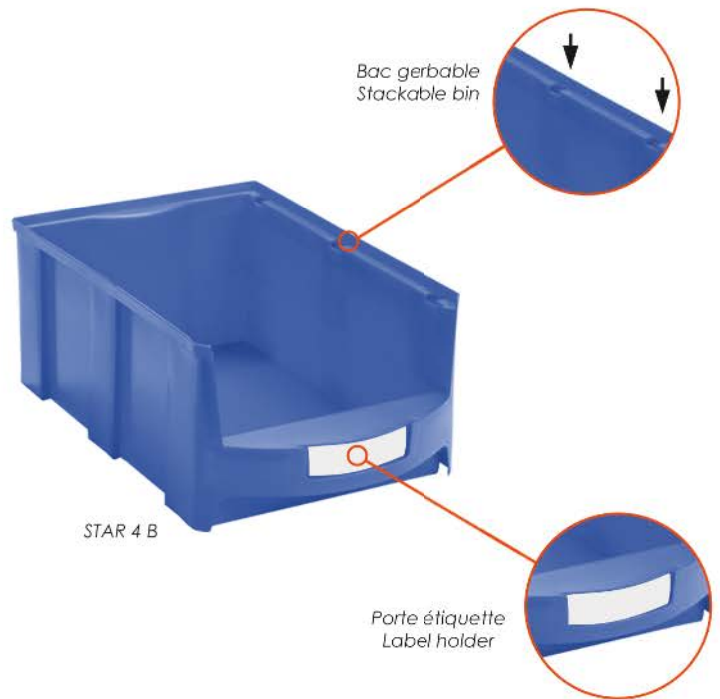

STAR 4 B



Code		Litre	P x l x H INT mm	P x l x H EXT mm	ABC ⁽¹⁾		Kg
STAR 2 B	●	1	130 x 80 x 70	163 x 100 x 82	60 x 20	16	0,109
STAR 3 B	●	4	185 x 130 x 110	233 x 154 x 125	80 x 30	12	0,300
STAR 4 B	●	10	260 x 175 x 150	332 x 211 x 174	110 x 35	8	0,673
STAR 4 LB	●	14	330 x 225 x 145	419 x 260 x 165	110 x 40	6	0,820
STAR 5 B	●	28	415 x 275 x 170	502 x 319 x 199	160 x 40	6	1,450
STAR 2 R	●	1	130 x 80 x 70	163 x 100 x 82	60 x 20	16	0,109
STAR 3 R	●	4	185 x 130 x 110	233 x 154 x 125	80 x 30	12	0,300
STAR 4 R	●	10	260 x 175 x 150	332 x 211 x 174	110 x 35	8	0,673
STAR 4 LR	●	14	330 x 225 x 145	419 x 260 x 165	110 x 40	6	0,820
STAR 5 R	●	28	415 x 275 x 170	502 x 319 x 199	160 x 40	6	1,450
STAR 2 T	○	1	130 x 80 x 70	163 x 100 x 82	60 x 20	16	0,109
STAR 3 T	○	4	185 x 130 x 110	233 x 154 x 125	80 x 30	12	0,300
STAR 4 T	○	10	260 x 175 x 150	332 x 211 x 174	110 x 35	8	0,673
STAR 4 LT	○	14	330 x 225 x 145	419 x 260 x 165	110 x 40	6	0,820
STAR 5 T	○	28	415 x 275 x 170	502 x 319 x 199	160 x 40	6	1,450

Livré sans étiquette / Delivery without label

(1) Taille porte étiquette / Label holder size



BAC A MONTER « AKI »

Les bacs à monter sont très économiques, ils vous permettent d'organiser le stockage et vos ateliers. Fabriqués en polypropylène alvéolaire épaisseur de 2.5 mm et densité 47C g/m2. Ils se montent en quelques secondes.

SELF ASSEMBLY BINS « AKI »

Self assembly bins to organize your workshop. Made of extruded polypropylene thickness 2.5 mm and 470 g/m2 density, you can set them up in a second.

Facile à assembler
Easy to assemble



A600B

Épaisseur 2,5 mm
Thickness 2,5 mm

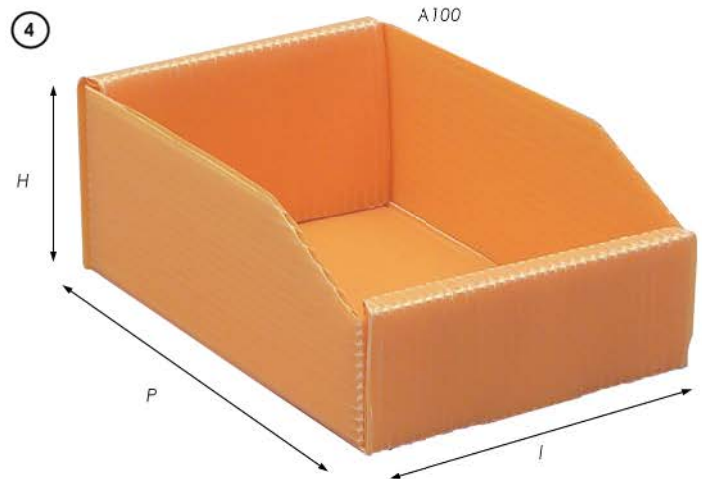
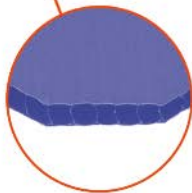

Caractéristiques

- Fabriqué en polypropylène alvéolaire
- Épaisseur 2,5 mm
- Densité 470 g/m2

Specifications

- Made of extruded polypropylene
- Thickness 2.5 mm
- Density 470 g/m2

Code		Litre	P x l x H mm		Kg
A100		1	180 x 120 x 65	25	0,040
A100B		1	180 x 120 x 65	25	0,040
A200		2	280 x 90 x 105	25	0,060
A200B		2	280 x 90 x 105	25	0,060
A280		2,5	380 x 90 x 105	25	0,070
A280B		2,5	380 x 90 x 105	25	0,070
A430		4,3	280 x 180 x 105	25	0,080
A430B		4,3	280 x 180 x 105	25	0,080
A600		6	380 x 180 x 105	25	0,100
A600B		6	380 x 180 x 105	25	0,100
A900		9	380 x 180 x 155	25	0,120
A900B		9	380 x 180 x 155	25	0,120
A1600		16	380 x 300 x 155	25	0,200
A1600B		16	380 x 300 x 155	25	0,200



BAC TIROIR DRAWER BIN

OPTION SÉPARATEURS / DIVIDERS

Étiquettes amovibles livrées avec les séparateurs

Labels delivery with dividers

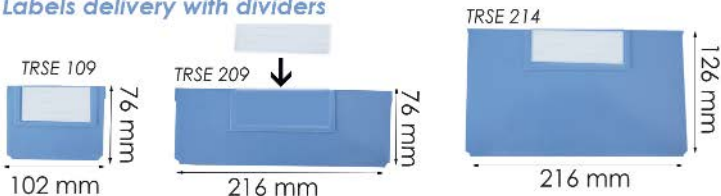

REF	DIM.EXT (mm)	Quantité / Quantity *	KG
TRSE 109	102 x 76 x 10	10	0,02
TRSE 209	216 x 76 x 10	10	0,03
TRSE 214	216 x 126 x 10	10	0,05

* Minimum de commande / Minimum order

- Polypropylène
- Porte étiquettes
- Gerbable
- 4 profondeurs (300/400/500/600 mm)
- Séparateurs horizontaux amovibles en option
- Séparateurs livrés avec étiquettes

- Polypropylène
- Label holder
- Stackable
- 4 deepness (300/400/500/600 mm)
- Horizontal and removable dividers as option
- Divider delivery with labels



REF	DIM.EXT (mm)	KG
TR 3109	300 x 117 x 90	0,24
TR 3209	300 x 234 x 90	0,42
TR 3214	300 x 234 x 140	0,56



REF	DIM.EXT (mm)	KG
TR 5109	500 x 117 x 90	0,36
TR 5209	500 x 234 x 90	0,62
TR 5214	500 x 234 x 140	0,76



REF	DIM.EXT (mm)	KG
TR 4109	400 x 117 x 90	0,29
TR 4209	400 x 234 x 90	0,51
TR 4214	400 x 234 x 140	0,69

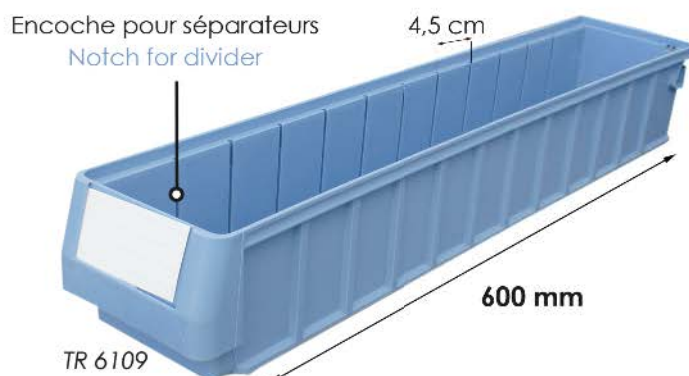

REF	DIM.EXT (mm)	KG
TR 6109	600 x 117 x 90	0,44
TR 6209	600 x 234 x 90	0,70
TR 6214	600 x 234 x 140	0,88



RACK ATELIER POUR BACS

Racks à poser sur un établi ou directement au sol. Équipés de bacs à bec avec une grande ouverture pour un rangement rationnel. Bacs en polypropylène et rack en acier, ils sont livrés prêts à monter.



MAS 20 B



Porte étiquette
Label holder



MAS 10 R

WORKBENCH SHELF FOR BINS

Workbench shelves made of steel. To be placed on the floor or on a workbench. They are provided with polypropylene storage bins.



MAK 30 R



MAK 20 B

Code		Litre	P x l x H mm	Kg
MAS 10 R *	●	4 x 0.33L + 12 x 1L	270 x 420 x 440	11,0
MAS 10 B *	●	4 x 0.33L + 12 x 1L	270 x 420 x 440	11,0
MAS 20 R *	●	4 x 0.33L + 12 x 1L	290 x 420 x 520	11,0
MAS 20 B *	●	4 x 0.33L + 12 x 1L	290 x 420 x 520	11,0
MAS 30 R *	●	5 x 4L + 8 x 10L	300 x 880 x 520	15,0
MAS 30 B *	●	5 x 4L + 8 x 10L	300 x 880 x 520	15,0
MAK 20 R *	●	6 x 0.33L + 12 x 1L + 16 x 4L	290 x 680 x 1070	17,0
MAK 20 B *	●	6 x 0.33L + 12 x 1L + 16 x 4L	290 x 680 x 1070	17,0
MAK 30 R *	●	15 x 4L + 12 x 10L	290 x 880 x 1090	26,0
MAK 30 B *	●	15 x 4L + 12 x 10L	290 x 880 x 1090	26,0

Livré sans étiquette / Delivery without label

* Sur commande / Special order



RAYONNAGE POUR GRANDS BACS

Rayonnage simple ou double face fabriqué en acier et équipé de bacs à bec en polypropylène et de roulettes pour la série « MAT ». Les modèles de la série « AR » sont en simple face. Rapide et facile à monter.

WORKBENCH SHELVES FOR LARGE BINS

Double side shelving « MAT » or single « AR » made of steel and provided with polypropylene storage bins. Easy to assemble.

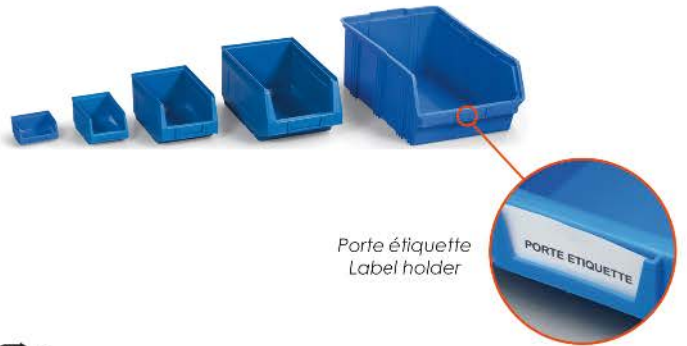

MAT 20



AR 04



AR 05

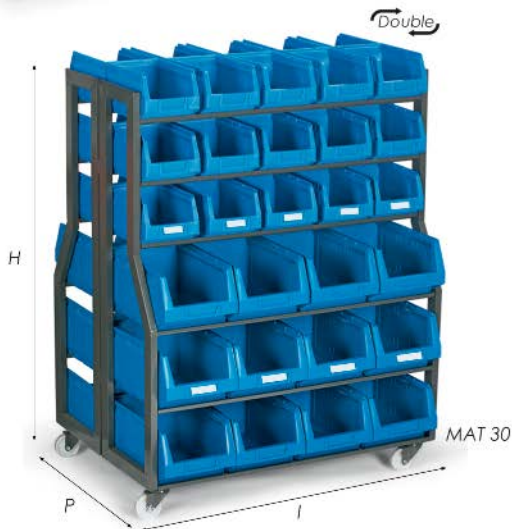

MAT 30

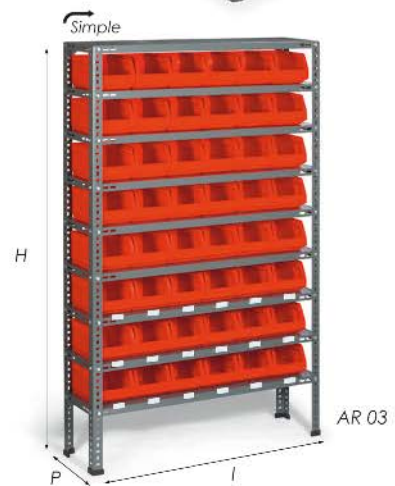

AR 03

Code		Litre	P x l x H mm	Kg
MAT 20 R*		24 x 1L + 32 x 4L	540 x 680 x 1170	32,00
MAT 20 B*		24 x 1L + 32 x 4L	540 x 680 x 1170	32,00
MAT 30 R*		30 x 4L + 24 x 10L	600 x 880 x 1200	51,00
MAT 30 B*		30 x 4L + 24 x 10L	600 x 880 x 1200	51,00

Livré sans étiquette / Delivery without label * Sur commande / Special order

Code		Litre	P x l x H mm	Kg
AR 03 R*		48 x 4L	260 x 1000 x 1600	47,00
AR 03 B*		48 x 4L	260 x 1000 x 1600	47,00
AR 04 R*		28 x 10 L	300 x 930 x 1600	49,00
AR 04 B*		28 x 10 l	300 x 930 x 1600	49,00
AR 05 R*		18 x 28L	430 x 1060 x 1600	51,00
AR 05 B*		18 x 28L	430 x 1060 x 1600	51,00

Livré sans étiquette / Delivery without label * Sur commande / Special order



ARMOIRE

Armoires professionnelles en acier. Livrées avec ou sans bacs en polypropylène, deux versions sont disponibles : avec ou sans portes. Fabriquées en acier et livrées prêt à monter.

CUPBOARD

Professional cupboards to store your accessories. Can be supplied with or without polypropylene bins. Each cupboard is available with or without doors. Made of steel, they are easy to assemble.

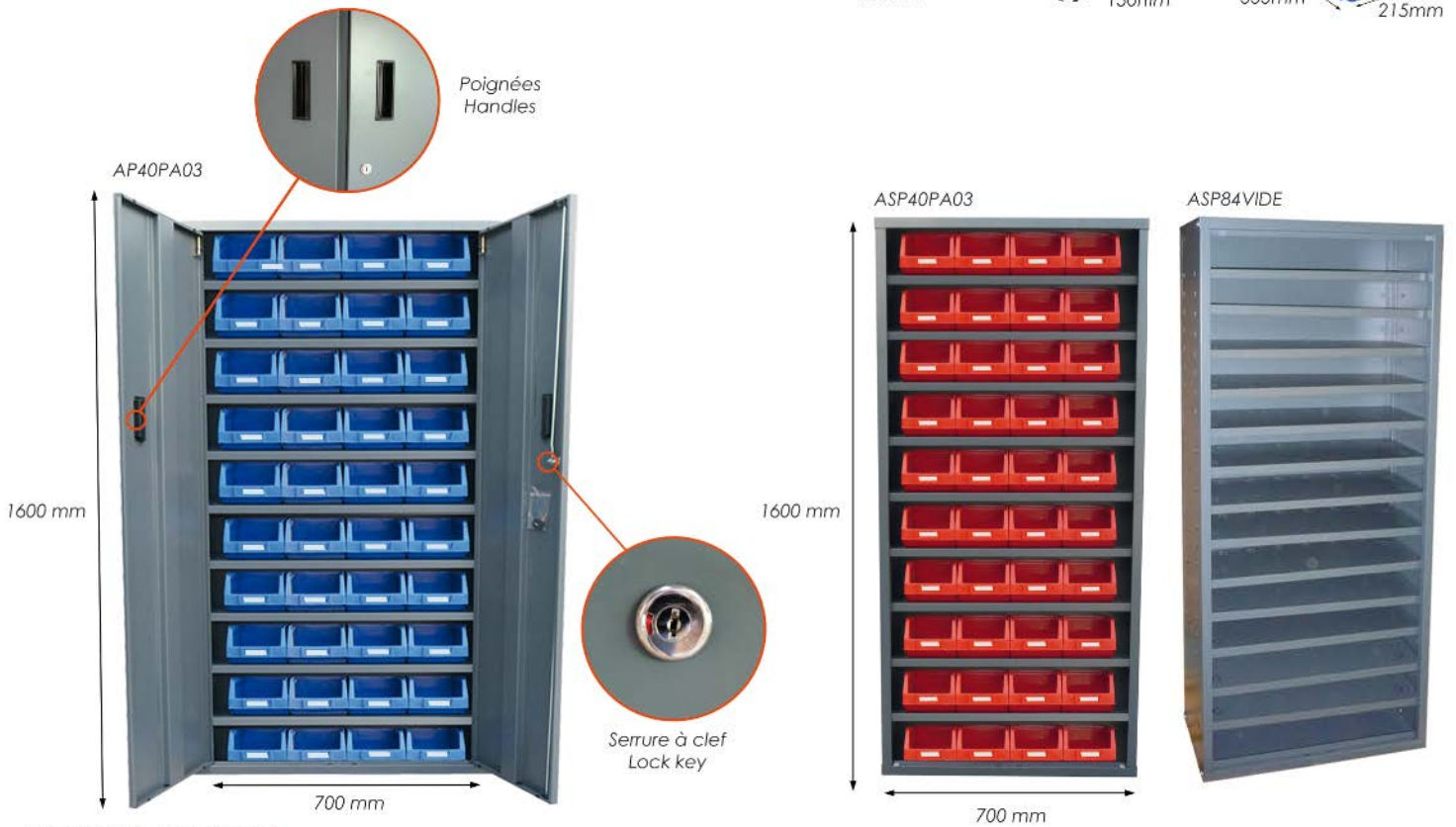

AVEC PORTES / WITH DOORS

Caractéristiques

- Serrure à clef
- 15 Kg par tablette
- Poignées d'ouverture
- Bacs avec porte étiquettes
- Livré sans étiquette
- Montage facile

Specifications

- Lock key
- Up to 15 Kg by shelf
- Door handles
- Bins with label holder
- Delivery without labels
- Easy to assemble

Code		Litre	P x l x H mm		Kg
AP84PA02		84 x 1L	260 x 760 x 1600	13	61,5
AP84PA02R		84 x 1L	260 x 760 x 1600	13	61,5
AP84VIDE		0	260 x 760 x 1600	13	54,5
AP40PA03		40 x 4L	260 x 760 x 1600	9	58,0
AP40PA03R		40 x 4L	260 x 760 x 1600	9	58,0
AP40VIDE		0	260 x 760 x 1600	9	48,0
AP32PA04		32 x 10L	400 x 960 x 1600	7	81,0
AP32PA04R		32 x 10L	400 x 960 x 1600	7	81,0
AP32VIDE		0	400 x 960 x 1600	7	65,0

SANS PORTES / WITHOUT DOORS

Caractéristiques

- Bacs avec porte étiquettes
- 15 Kg par tablette
- Livré sans étiquette
- Montage facile

Specifications

- Bins with label holder
- Up to 15 Kg by shelf
- Delivery without label
- Easy to assemble

Code		Litre	P x l x H mm		Kg
ASP84PA02		84 x 1L	260 x 760 x 1600	13	50,0
ASP84PA02R		84 x 1L	260 x 760 x 1600	13	50,0
ASP84VIDE		0	260 x 760 x 1600	13	43,0
ASP40PA03		40 x 4L	260 x 760 x 1600	9	42,0
ASP40PA03R		40 x 4L	260 x 760 x 1600	9	42,0
ASP40VIDE		0	260 x 760 x 1600	9	37,0
ASP32PA04		32 x 10L	400 x 960 x 1600	7	67,0
ASP32PA04R		32 x 10L	400 x 960 x 1600	7	67,0
ASP32VIDE		0	400 x 960 x 1600	7	52,0

BACS CRATES



BAC PICKING PICKING CRATE

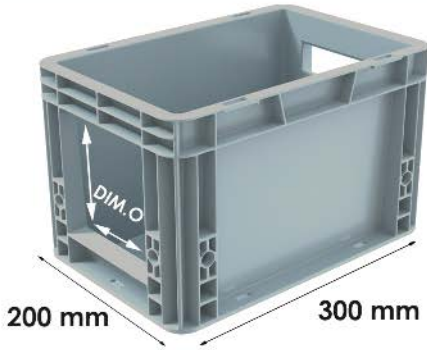

SPK 3220 AV/21

- Polypropylène
- Norme Europe
- Gerbable
- Bac renforcé
- Température d'utilisation :
- 0°C / +60°C

- Polypropylene
- Euronorm crates
- Stackable
- Strengthened crate
- Can be used between :
- 0°C / +60°C



REF	LITRE	DIM.EXT (mm)	DIM.O (mm)	MAX (KG)	KG
SPK 3220 AV/21	7	200 x 300 x 190	114 x 108	15	0,59

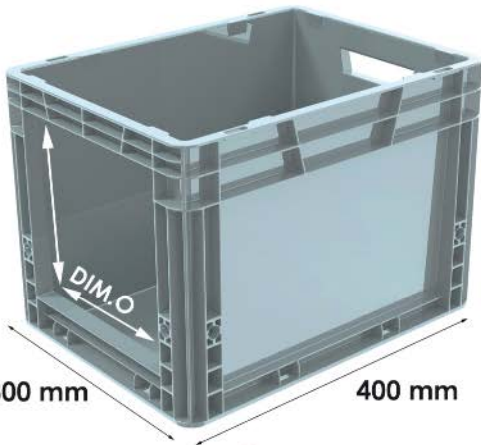

SPK 4329 AV/21



SPK 15 AV

REF	LITRE	DIM.EXT (mm)	DIM.O (mm)	MAX (KG)	KG
SPK 4322 AV/21	20	300 x 400 x 230	200 x 120	20	1,25
SPK 4329 AV/21	25	300 x 400 x 290	200 x 170	20	1,45

REF	LITRE	DIM.EXT (mm)	DIM.O (mm)	MAX (KG)	KG
SPK 15 AV *	16	260 x 505 x 165	155 x 97	35	1,11
SPK 20 AV *	21	260 x 505 x 210	155 x 156	35	1,40

*Sur commande / Special order

SPK 4623 AV/21

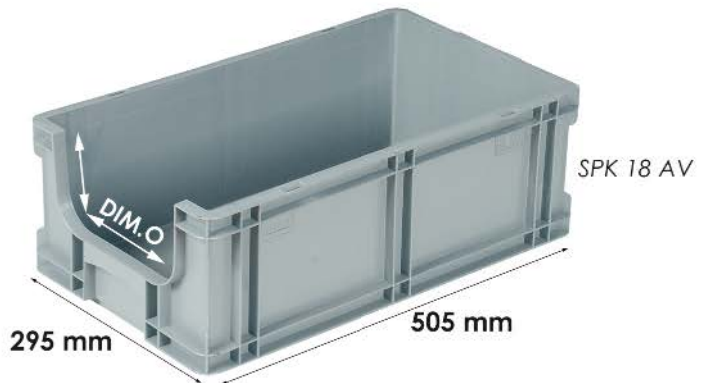
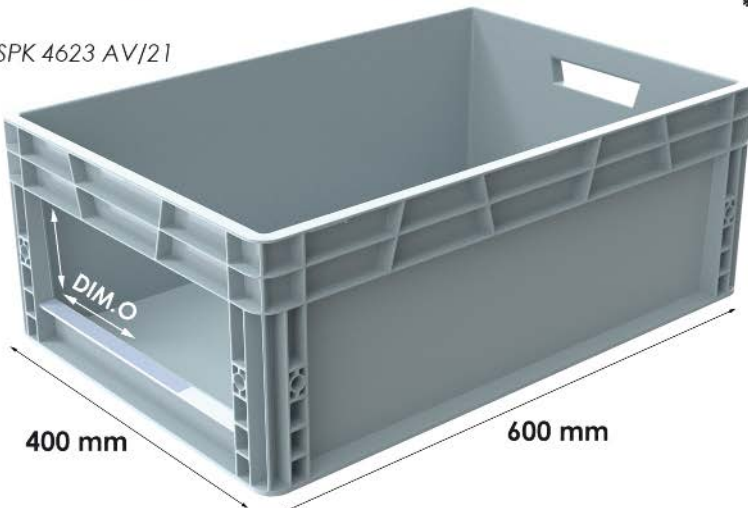

SPK 18 AV

REF	LITRE	DIM.EXT (mm)	DIM.O (mm)	MAX (KG)	KG
SPK 4623 AV/21	45	400 x 600 x 230	310 x 130	30	2,10
SPK 4628 AV/21	55	400 x 600 x 290	310 x 180	30	2,65
SPK 4632 AV/21	65	400 x 600 x 340	310 x 220	40	3,00
SPK 4642 AV/21	90	400 x 600 x 445	310 x 220	50	3,25
SPK 4642 LO/21	90	400 x 600 x 445	515 x 338	30	3,15

REF	LITRE	DIM.EXT (mm)	DIM.O (mm)	MAX (KG)	KG
SPK 18 AV *	20	295 x 505 x 180	194 x 94	35	1,26
SPK 27 AV *	27	295 x 505 x 235	194 x 158	35	1,51

*Sur commande
Special order

BACS CRATES



BAC NORME EUROPE EURONORME CRATE



REF	LITRE	DIM.EXT (mm)	MAX (KG)	KG
E 3211/21	5	300 x 200 x 120	15	0,49

- Polypropylène
- Norme Europe
- Gerbable
- Bac renforcé
- Couvercle en option
- Température d'utilisation :
• 0°C / +60°C

- Polypropylene
- Euronorm crates
- Stackable
- Streghtened crate
- Lid sold as option
- Can be used between
• 0°C / + 60°C



Fond renforcé
Reinforced bottom

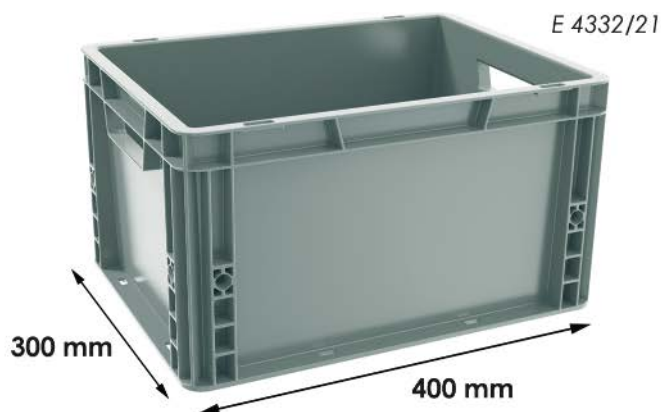

REF	LITRE	DIM.EXT (mm)	MAX (KG)	KG
E 4312/21	10	400 x 300 x 120	15	0,80
E 4316/21	15	400 x 300 x 165	20	1,05
E 4322/21	20	400 x 300 x 230	20	1,35
E 4332/21	25	400 x 300 x 290	20	1,55

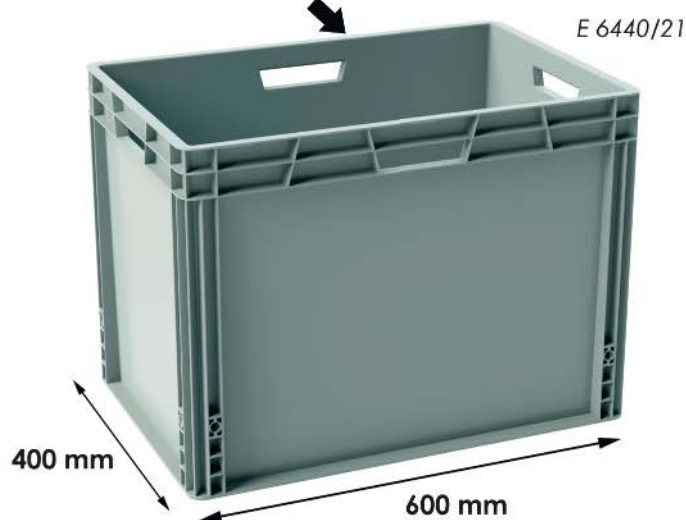

REF	LITRE	DIM.EXT (mm)	MAX (KG)	KG
E 6412/21	20	600 x 400 x 100	20	1,45
E 6417/21	35	600 x 400 x 165	25	1,75
E 6420/21	45	600 x 400 x 220	30	2,30
E 6428/21	55	600 x 400 x 290	30	2,75
E 6432/21	65	600 x 400 x 340	40	3,20
E 6440/21	90	600 x 400 x 445	50	3,45

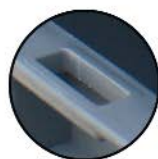

Possibilité de fermeture avec un lien.
Can be closed with ties.



REF	DIM.EXT (mm)	KG
E 3201/21	300 x 200 x 3	0,15
E 4301/21	400 x 300 x 4	0,35
E 6401/21	600 x 400 x 6	0,89



REF	DIM.EXT (mm)	MAX (KG)	KG
E 8888	610 x 410 x 160	250	3,25



BP SÉRIE

BAC PLIANT PROFESSIONNEL

Bacs pliants professionnels permettant le transport de marchandises. Disponibles en trois versions selon les besoins (30, 45 et 60 litres). Hauteur pliée de 54 mm pour un rangement facile, ils sont munis de charnières en acier pour une solidité renforcée. Qualité alimentaire.

FOLDABLE CRATE

Foldable crates made to carry goods. They are available in 3 dimensions : 30, 45 and 60 litres. They are stackable and can be folded 54 mm height. Made of polypropylene (food approved) and have steel hinges to assure the best quality and time value.

BP 223 BL



Poignée de transport
Carrying handle



Charnières acier (BP223 + BP60)
Steel hinges (BP223 + BP 60)

BP 320 BL





Caractéristiques

- Bac pliant
- Fabriqué en polypropylène
- Gerbable
- Charnières en acier (BP 223+BP60)
- Poignées confort

Specifications

- Foldable crates
- Made of polypropylene
- Stackable
- Steel hinges (BP 223+BP60)
- Soft handles



Code	L x l x H mm EXT	L x l x H mm INT	MAX	LITRE			Kg
BP 320 BL	475 x 350 x 235	460 x 335 x 225	15 Kg	30	60/120	5	0,8
BP 223 BL	525 x 365 x 270	490 x 330 x 260	20 kg	45	60/120	5	1,50
BP 60 BL	575 x 380 x 290	540 x 335 x 285	20 kg	60	60/120	5	1,90



BAC NORME EUROPE

Bacs norme Europe (CE 10/2010) s'adaptant parfaitement aux palettes Europe (80 x 120 cm). Ils sont fabriqués en polypropylène. Le bac P 6420-00 est pliant en plus d'être gerbable tandis que les bacs série E sont uniquement gerbables.

EURONORM CRATE

Euronorm crates (CE 10/2010) made to fit euronorm palets (80 x 120 cm). They are made of polypropylene to ensure the best quality and time value. P 6420 - 00 are foldable and stackable while E série are only stackable.



E 6432-00

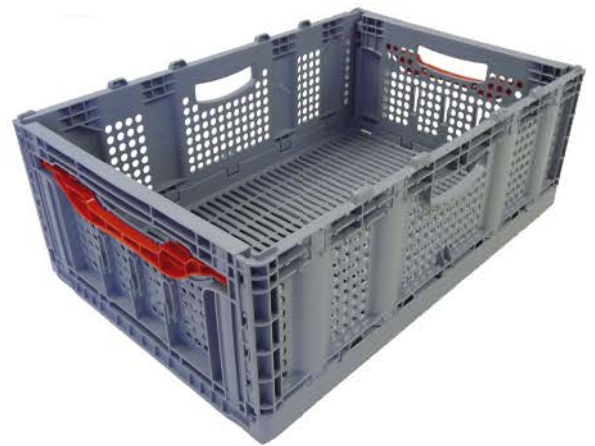

P 6420 - 00

E 4301 / E 6401



E 8888



Caractéristiques

- Bac norme Europe
- Fabriqué en polypropylène
- Gerbable
- Fond renforcé
- Couverture amovible en option

Specifications

- Euronorm crates
- Made of polypropylene
- Stackable
- Strengthened bottom
- Lid sold as option

Hauteur pliée 51 mm
Height folded 51 mm

Caractéristiques

- Bac pliant
- Gerbable
- Fond et parois renforcées
- Qualité alimentaire
- Norme Europe
- Fabriqué en polypropylène

Specifications

- Foldable crate
- Stackable
- Heavy duty lid bottom and sides
- Food approved
- Euronorm
- Made of polypropylene

Code	INT mm	EXT mm	MAX	LITRE		Kg
E 6420-00	550 x 360 x 190	600 x 400 x 200	20 kg	30	20/36	1,50
E 6432-00	555 x 355 x 315	600 x 400 x 320	25 kg	60	16/28	2,00
E 4301	-	400 x 300 x 20	-	-	-	0,35
E 6401	-	600 x 400 x 16	-	-	-	0,89
E 8888	-	610 x 410 x 160	250 kg	-	-	3,25

Code	L x l x H mm	LITRE	MAX		Kg
P 6420-00	600 x 400 x 220	40	20 kg	1	2,30

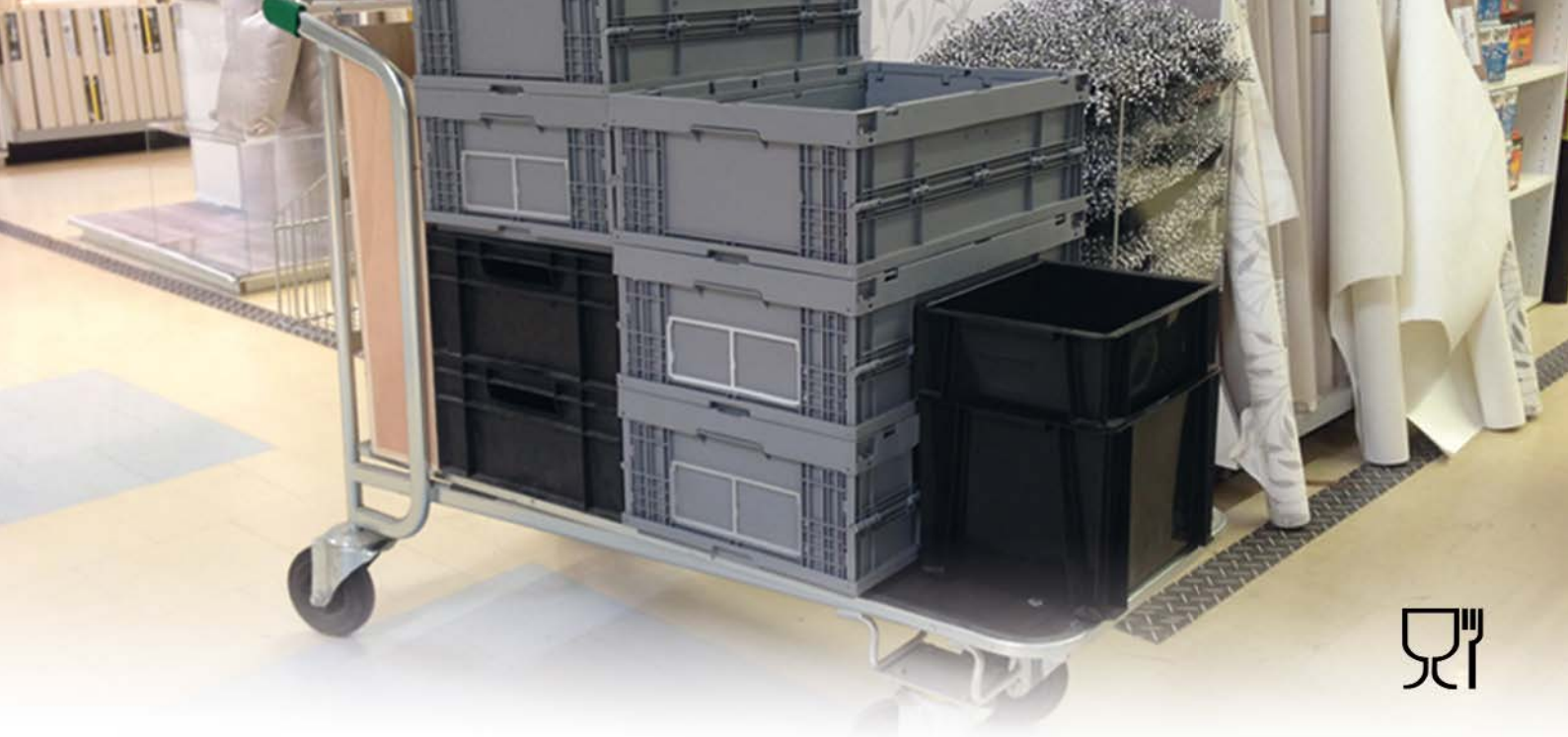

BAC PLIANT INDUSTRIEL

Bacs pliants industriels fabriqués en polypropylène de qualité alimentaire. Ils sont norme Europe et palettisables. La hauteur pliée est pour la série EP est de 74 mm, celle pour le bac EPC 6433 est de 90 mm.

INDUSTRIAL FOLDABLE CRATE

Euronorm foldable crates made of food approved polypropylene. Their height when folded is only 74 mm (EP SERIE) or 90 mm (EPC 6433).



EP 6423



EPC 6433

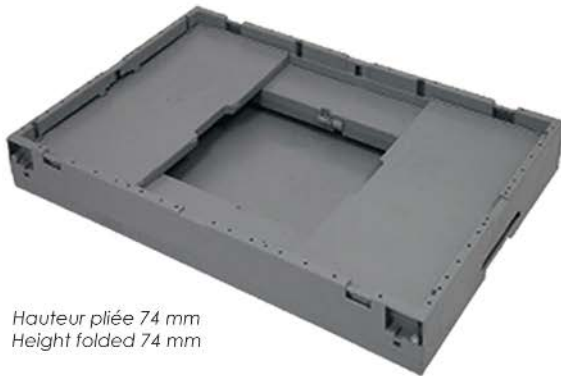

Hauteur pliée 74 mm
Height folded 74 mm

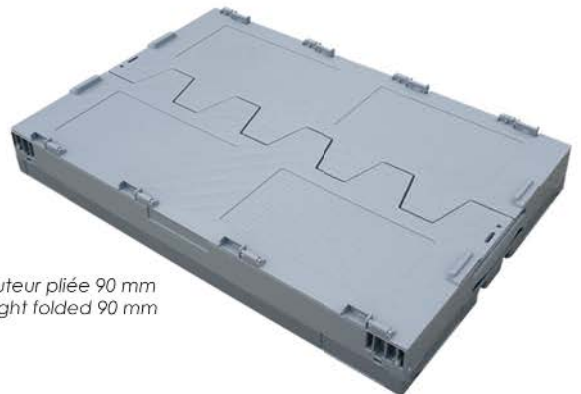

Hauteur pliée 90 mm
Height folded 90 mm

Code	L x l x H mm	LITRE	MAX		Kg
EP 4323	400 x 300 x 220	20	20 kg	1	1,50
EP 6423	600 x 400 x 220	40	20 kg	1	2,40
EP 6433	600 x 400 x 320	60	20 kg	1	3,00

Code	EXT mm	LITRE	MAX		Kg
EPC 6433	600 x 400 x 320	59	30 kg	1	3,85

BACS CRATES



BAC NAVETTE NESTABLE CRATE

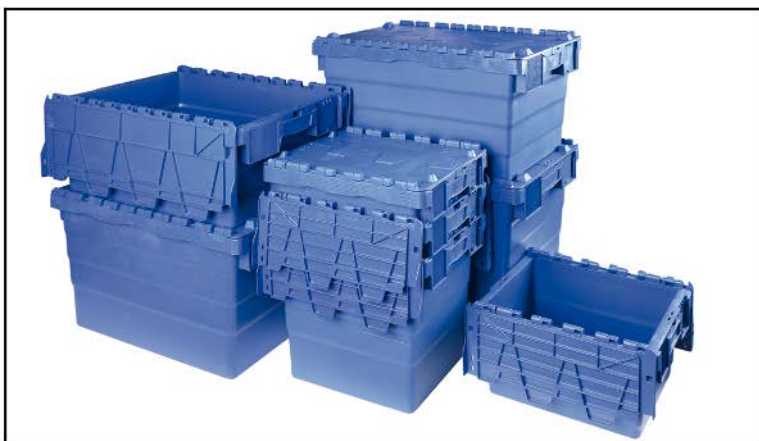

- Polypropylène
- Gerbable
- Porte étiquette
- Fermeture avec lien
- Poignées ergonomiques

- Polypropylene
- Stackable
- Label holder
- Closing with ties
- Ergonomic handle

400 x 600 mm



300 x 400 mm



Poignée ergonomique
Ergonomic handle



Fermeture avec lien
Can be closed with ties



REF	LITRE	MAX kg (dynamic)	DIM.EXT (mm)	KG
DSW 4321	16	20	300 x 400 x 200	1,4
DSW 4325	22	20	300 x 400 x 250	1,5
DSW 4332	27	20	300 x 400 x 320	1,6
DSW 4336	32	20	300 x 400 x 365	1,7

REF	LITRE	MAX kg (dynamic)	DIM.EXT (mm)	KG
DSW 5527	44	30	400 x 600 x 250	2,6
DSW 5536	54	30	400 x 600 x 320	2,9
DSW 5539	64	30	400 x 600 x 365	3,5
DSW 5541	78	30	400 x 600 x 416	3,8

KOFPRO



COFFRE INDUSTRIEL « KOFPRO »

Les coffres industriels « KOFPRO » sont fabriqués en polyéthylène haute densité, norme Europe et palettisables. Étanches à l'eau et à la poussière, ils sont aussi équipés de pieds de superposition pour éviter tout mouvement lors du transport. Les modèles KOFPRO 841, 861, 1041 sont équipés de roues en polyamide de diamètre 125 mm et d'une grande poignée de traction. Température d'utilisation -40°C +80°C. Résistants aux graisses bases et acides. Traités anti-UV, ils sont aptent au contact alimentaire. Les KOFPRO sont certifiés IP X 5.

INDUSTRIAL CHEST « KOFPRO »

Our new range of euronorm chests is made of high density polyethylene and is dedicated to an industrial use. Waterproof and dustproof, they are stackable and have feet for stacking them securely up to 5. KOFPRO 841, 861, 1041 have polyamide wheels Ø 125 mm and a large pulling handle. They can be used from -40°C to +80°C and resist to grease, base and acids. UV resistant they are also food approved. Standard IP X 5.

IP X 5



KOFPRO 841

Poignée de transport
Handle

Fermeture sécurisée
Secure lock

Roues Ø 125 mm (modèles 841-861-1041)
Wheels Ø 125 mm (models 841-861-1041)

Photos non contractuelles



Caractéristiques

- Fabriqué en polyéthylène
- Superposable jusqu'à 5
- Pieds facilitant la superposition
- Étanche à l'eau et poussière
- 2 poignées latérales intégrées
- Roues ø 125 mm (KOFPRO 841,861,1041)
- Poignée de traction (KOFPRO 841,861,1041)
- Apté au contact alimentaire
- 12 h de conservation avec glace
- Paletisable sur palette europe
- Lavable, anti UV
- Température -40/+80°C
- Résiste aux graisses, bases et acides
- Garantie 2 ans

Specifications

- Made of polyethylene
- Stackable up to 5
- Feet design to facilitate superimposing
- Waterproof and dustproof
- 2 sides handles integrated
- Wheels ø 125 mm (KOFPRO 841,861,1041)
- Pulling handle (KOFPRO 841,861,1041)
- Food approved
- 12 h food storage with ice
- Can be placed onto europalet
- Washable, UV proof
- Temperature -40/+80°C
- Acid, grease and base resistant
- 2 years guarantee



Fermeture sécurisée
Secure lock



Joint d'étanchéité
Seal



KOFPRO 451



KOFPRO 1041



Code	L x l x H mm EXT	L x l x H mm INT	MAX STATIC	MAX DYNAMIC	Volume INTERNE	Ø Roues Wheels mm	Kg
KOFPRO 451	450 x 400 x 350	360 x 340 x 250	100 Kg	75 Kg	28 L	-	4,00
KOFPRO 641	600 x 400 x 550	510 x 335 x 425	150 Kg	110 Kg	75 L	-	5,00
KOFPRO 841	800 x 400 x 550	710 x 335 x 425	125 Kg	90 Kg	104 L	Ø 125	9,50
KOFPRO 861	800 x 600 x 550	705 x 540 x 430	125 Kg	90 Kg	167 L	Ø 125	11,20
KOFPRO 1041	1000 x 400 x 550	750 x 340 x 420	150 Kg	105 Kg	140 L	Ø 125	10,50

MALLE

MALLE MULTIFONCTIONS

Malles de transport et de stockage composées d'une structure en aluminium et de panneaux en contreplaqué (MDF) recouvert de PVC. Pour un transport de marchandise efficace en toute sécurité, les malles possèdent des verrous ainsi que des coins renforcés. Elles sont équipées de deux poignées latérales de transport et d'une frontale pour les modèles S et M. Les modèles WS et WM sont équipés d'une poignée télescopique. Des roues sont en option pour les modèles L - XL - XXL. Mousse en option.

MULTIFUNCTION CHEST

Transport chests made of aluminium structure. Panels are made of MDF and covered with PVC sheets. Supplied with 2 sides handles and one at the front for S & M types. Corners are reinforced and closures are locked with keys. Telescopic handle for WS/WM models. Wheels as option for L - XL - XXL models. Foam as option.

MALLE S



Verrous à clés
Closure with keys



Coins renforcés
Reinforced corners

MALLE W KIT - 2 avec freins / 2 with brakes
(L - XL - XXL)



Lanières de soutien
Straps to keep opened



MALLE M

MALLE MULTIFONCTIONS MULTIFUNCTION CHEST

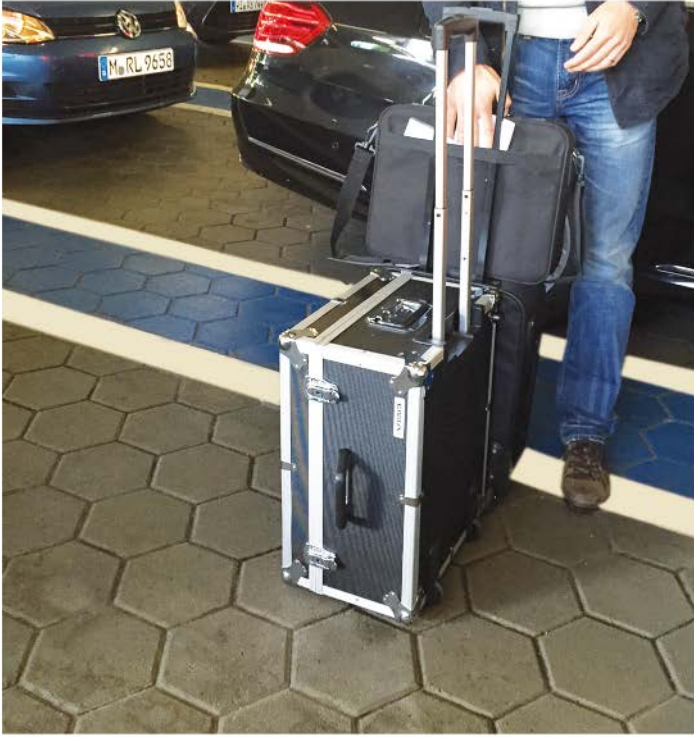

Caractéristiques

- Malle multi usage
- Poignée à l'avant (S/M)
- Poignée télescopique (WS/WM)
- Fermetures à clés
- Extérieur en PVC
- Intérieur en mousse PU
- Structure aluminium

Specifications

- Multi use chest
- Front handle (S/M)
- Telescopic handle (WS/WM)
- Secure locks
- Outside made of PVC
- Inside with PU foam
- Aluminium structure



MALLE WM

MALLE WS



Mousse prédécoupée en option
Precuted foam as option



Roulettes Ø 60 mm
Wheels Ø 60 mm



Photos non contractuelles

Code	L x l x H mm EXT	L x l x H mm INT	MAX	LITRE		Kg
MALLE S	450 x 350 x 210	430 x 330 x 190	13 kg	27	1	3,40
MALLE M	500 x 400 x 260	480 x 380 x 240	15 kg	44	1	4,00
MALLE L	550 x 450 x 310	530 x 430 x 290	18 kg	66	1	4,80
MALLE XL	600 x 500 x 360	580 x 480 x 340	25 kg	94	1	5,70
MALLE XXL	650 x 550 x 410	630 x 530 x 390	30 kg	130	1	6,60
MALLE WS	450 x 350 x 210	430 x 330 x 150	13 kg	20	1	4,40
MALLE WM	500 x 400 x 260	480 x 380 x 190	15 kg	34	1	6,50
MALLE W KIT	4 x ø 50	L - XL - XXL	-	-	-	2,60
MOUSSE	625 x 525 x 90	-	-	-	-	0,70



ALUR

COFFRE ALUMINIUM HAUTE RÉSIDANCE

Coffres de chantier en aluminium (de 37 à 470 litres), épaisseur 3 mm, pouvant être fixés sur des plateformes de travail, camion ou pick-up grâce au filetage M10 sur chaque angle. Ils sont équipés de poignées rivetées en inox : confortables, antiderapantes et rabattables. Les verrous sont quant à eux en acier inoxydable et rivetés avec fermeture par cadenas (cadenas vendus en option). Les couvercles sont retenus par des sangles ou des verrins à gaz (pour les plus gros modèles). Les coffres ALUR ne rouillent pas, ne craignent pas l'eau grâce à un joint d'étanchéité en caoutchouc sur le cadre.

HEAVY DUTY ALUMINIUM BOX

Heavy duty aluminium boxes from 37 to 470 L (thickness 3 mm) which can also be fixed on platforms or pickup thanks to a M10 thread. ALUR have a stainless steel handle : comfortable, anti-slip and foldable. The stainless steel closing device (2 or 3 depending on model) are riveted, closing with padlock (option). Lids are retained by straps or gas cylinders (for larger models). ALUR are resistant to water Rubber Seal on the frame for rainproof.

ALUR 37

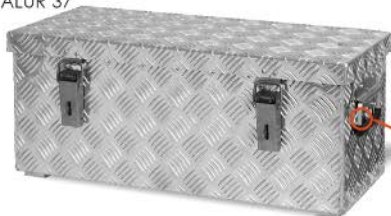

Poignée en inox
Stainless steel handle



ALUR 234



Verrou en inox
Stainless steel closing device

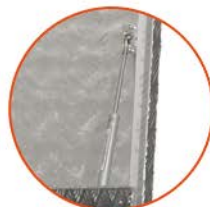

Verrin à gaz
Gas cylinder



ALUR 883



ALU 41000
(Jeu de 4 / Set of 4)

Code	L x l x H mm EXT	L x l x H mm INT	LITRE	Kg
ALUR 37	622 x 275 x 270	600 x 250 x 250	37	6,70
ALUR 70	522 x 375 x 420	500 x 350 x 400	70	8,64
ALUR 120	622 x 425 x 520	600 x 400 x 500	120	11,78
ALUR 234	772 x 525 x 645	750 x 500 x 625	234	17,66
ALUR 250	1022 x 525 x 520	1000 x 500 x 500	250	19,34
ALUR 312	1272 x 525 x 520	1250 x 500 x 500	312	22,72
ALUR 375	1522 x 525 x 520	1500 x 500 x 500	375	26,74
ALUR 470	1896 x 525 x 520	1874 x 500 x 500	470	32,02
ALUR 883	1700 x 700 x 750	1678 x 675 x 730	883	43,30
ALU 41000	200 x 155 x 155	-	-	2,66



MALLE ALUMINIUM

Fabriquées en aluminium 10/10e, ces malles, de 29 à 425 litres, possèdent deux lanières qui permettent de retenir le couvercle lors de l'ouverture. D'une grande résistance, elles résistent aux déformations, à la corrosion et aux intempéries. Les coins sont renforcés et permettent la superposition des malles. Elles sont équipées de verrous de fermeture en inox (serrures en option : ALUD 31008). Les poignées de sécurité antidérapantes sont rabattables.



ALUMINIUM CRATE

Aluminium crates from 29 to 425 L (thickness of 10/10e) with stacking polypropylene corners. Crates can resist to corrosion and bad weather. They have stainless steel closing device with optional key locks (ALUD 31008). Foldable and comfortable handles. Lid is equipped with steel hinges and retaining straps.

Serrures - ALUD 31008 (option - lot de 2)
Locks - ALUD 31008 (option - Set of 2)



Malle gerbable
Stackable crate



Poignées ergonomique
Ergonomic handle



ALUD 29



ALUD 415

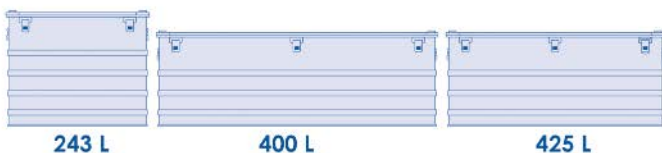
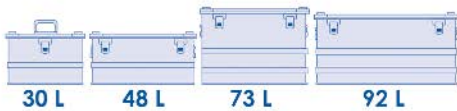

Code	L x l x H mm EXT	L x l x H mm INT	LITRE	Kg
ALUD 29	430 x 335 x 277	400 x 300 x 248	30	2,86
ALUD 47	580 x 385 x 277	550 x 350 x 248	48	4,09
ALUD 76	580 x 385 x 410	550 x 350 x 381	73	4,60
ALUD 91	780 x 385 x 379	750 x 350 x 350	92	5,45
ALUD 140	900 x 495 x 379	870 x 460 x 350	140	6,95
ALUD 157	782 x 585 x 410	750 x 550 x 381	157	7,06
ALUD 163	1182 x 385 x 410	1150 x 350 x 381	153	8,63
ALUD 240	782 x 585 x 619	750 x 550 x 590	240	8,36
ALUD 400	1532 x 585 x 514	1500 x 550 x 485	400	19,30
ALUD 415	1192 x 790 x 514	1160 x 755 x 485	425	13,86
ALU 31008	50 x 80 x 20	-	-	0,04

NEW



OFFICE

LOGIC

MALLE ALUMINIUM

OFFICE

Fabriqués en aluminium 10/10e, ces coffres avec couvercles de 50 et 74 litres sont conçus pour recevoir des classeurs, ou des dossiers suspendus grâce à 2 rails.

Pour faciliter l'accès aux documents, le couvercle s'enlève entièrement. Les 2 poignées latérales plastifiées, rabattables et antidérapantes permettent un transport confortable de ces coffres. Excellente résistance à la corrosion.

LOGIC

Fabriqués en aluminium 10/10e, ces bacs, tous équipés de poignées latérales antidérapantes sont superposables et palettisables sur palettes 120 x 80 cm.

De contenances comprises entre 23 et 191 litres, ils existent en 40 x 30 cm, 60 x 40 cm et 80 x 60 cm. 3 hauteurs sont disponibles, 29, 39 et 49 cm suivant les modèles. Excellente résistance à la déformation.

ALUMINIUM CRATE

OFFICE

Made of 10/10 aluminum, these boxes with lids of 50 and 74 L are designed to store files or even suspension files thanks to 2 rails inside the box. For an easier access to documents, the lid can be removed completely. The 2 folding and non-slip side handles allow a comfortable transport of these boxes. Excellent corrosion resistance.

LOGIC

Made of 10/10 aluminum, these boxes include non-slip side handles and can be stacked and also palletized on 120 x 80 cm pallets. With a capacity from 23 to 191 L, they are available in 40 x 30 cm, 60 x 40 cm and 80 x 60 cm and 3 different heights, 29, 39 and 49 cm depending on the reference. Excellent resistance to deformation.



Rails pour dossiers suspendus
Rails pour dossiers suspendus



Poignées ergonomique
Ergonomic handle



OFFICE 74



LOGIC 191

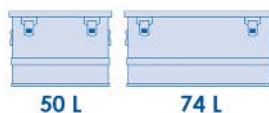

50 L

74 L

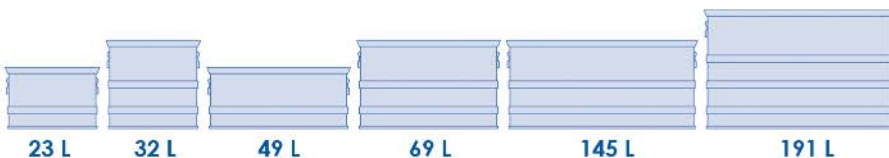

23 L

32 L

49 L

69 L

145 L

191 L

Code	L x l x H mm EXT	LITRE	Kg
OFFICE 50	430 x 430 x 325	50	3,20
OFFICE 74	630 x 430 x 325	74	4,14
LOGIC 23	388 x 290 x 265	23	1,61
LOGIC 32	388 x 290 x 367	32	1,87
LOGIC 49	588 x 390 x 265	49	2,47
LOGIC 69	588 x 390 x 367	69	2,86
LOGIC 145	781 x 590 x 367	145	4,34
LOGIC 191	781 x 590 x 477	191	5,00

WAT

IP 67

MALLETE DE PROTECTION ÉTANCHE

Mallettes étanches à l'eau et à la poussière. Antichocs, elles sont idéales pour transporter et présenter vos objets fragiles. Équipées de mousse crantée dans le couvercle, elles disposent de fermetures sécurisées, d'une valve de pression et de charnières en inox. Les modèles « TR » sont équipés de roulettes et d'une poignée télescopique. Les mallettes sont normées IP 67 (protection totale contre les poussières et les effets de l'immersion jusqu'à 1M). Autres coloris sur demande.

WATER TIGHT CASE

Water tight cases perfect to carry fragile products. Supplied with precut foam and egg crated foam in lid, they are built with stainless steel hinges and pressure release valve. Can be closed securely thanks to the front locks and locked with padlock not supplied. «TR» models are equipped with wheels and telescopic handle. All are standard IP 67 (dust tight and immersion up to 1 m). Other colors on request.

WAT 430



Photos non contractuelles

Caractéristiques

- Fabriqué en polypropylène
- Mallette étanche à l'eau et poussière
- Charnières inox
- Joint d'étanchéité
- Fermetures sécurisées
- Mousse crantée sous le couvercle
- Mousse prédécoupée dans le fond
- Certifié IP 67

Specifications

- Made of polypropylene
- Waterproof case
- Stainless steel hinges
- Case sealing
- Secure closings
- Alveolate foam on the top
- Precutted foam at the bottom
- IP 67 certification



Roulettes Ø 60 mm
Wheels Ø 60 mm



Fermeture par cadenas (non fourni)
Closure with padlock (not supplied)



Poignée télescopique
Telescopic handle



Mousse crantée
Egg crated foam



Sans roulettes / Without wheels

Code	INT mm	EXT mm	MAX		Kg
WAT 130	117 x 68 x 26	129 x 91 x 32	1 kg	1	0,11
WAT 140	213 X 116 X 50	239 X 144 X 70	2 kg	1	0,34
WAT 200	216 x 152 x 95	240 x 198 x 108	6 kg	1	0,75
WAT 210	186 x 123 x 75	210 X 167 X 90	5 kg	1	0,60
WAT 250	235 X 145 X 62	246 x 175 x 77	3 kg	1	0,45
WAT 270	405 x 231 x 260	428 x 283 x 275	15 kg	1	2,90
WAT 300	241 X 188 X 184	300 X 248 X 212	8 kg	1	1,70
WAT 330	300 X 220 X 101	330 X 280 X 120	8 kg	1	1,65
WAT 420	382 X 269 X 149	420 X 327 X 172	12 kg	1	2,50
WAT 430	395 X 320 X 117	430 X 380 X 154	15 kg	1	2,80
WAT 500	495 X 355 X 170	515 X 415 X 200	20 kg	1	3,60
WAT 515	485 X 355 X 145	515 X 415 X 165	20 kg	1	4,26

Avec roulettes / With wheels

Code	L x l x H mm INT	L x l x H mm EXT	MAX		Kg
WAT 18 TR*	442 X 350 X 175	475 X 390 X 200	20 kg	1	4,00
WAT 22 TR*	510 X 292 X 178	530 X 355 X 225	20 kg	1	4,80
WAT 26 TR*	510 X 290 X 252	530 X 355 X 290	25 kg	1	6,20
WAT 28 TR*	581 X 360 X 298	625 X 420 X 340	30 kg	1	7,70
WAT 975 **	912 x 370 x 135	975 x 430 x 168	35 kg	1	8,00
WAT 1130 TR**	1066 x 368 x 136	1133 x 422 x 155	40 kg	1	8,60
WAT 1350 TR**	1270 x 335 x 138	1346 x 394 x 165	40 kg	1	10,30

* Avec poignée télescopique / With telescopic handle

** Nous consulter pour le délai / Ask us for the lead time



MALLETE DE PRÉSENTATION « TK »

- Mallette de présentation
- Personnalisation sur commande (couleur, mousse)
- Fabriqué en polypropylène

PACKAGING CASE « TK »

- Packaging case
- Customization as order (color, foam)
- Made of polypropylene

Code	L x l x H mm EXT	L x l x H mm INT		Kg
TK 50	225 x 220 x 72	220 x 167 x 65	8	0,29
TK 70	330 x 270 x 80	325 x 265 x 72	6	0,46
TK 100	500 x 350 x 110	490 x 345 x 102	5	1,20



MALLETE DE RANGEMENT

Mallettes fabriquées en polypropylène vous permettant de conditionner vos produits dans un emballage professionnel et résistant. Toutes les personnalisations sont possibles : couleurs, marquage, mousse ...

TOOL & PACKING CASE

Range of polypropylene case build to pack your products in a professional way. Can be customized to your needs : colors, foam, printing ...

Code	L x l x H mm EXT	L x l x H mm INT		Kg
PM 02	405 x 300 x 155	375 x 240 x 140	12	1,20
PM 04*	405 x 300 x 140	400 x 240 x 138	12	0,95



BOITE COQUILLE

- Boîte de protection
- Cadre de maintien interne
- Anti-choc
- Personnalisation sur demande

SHELL CASE

- Plastic case
- Internal frame
- Shock proof
- Customization possible

Code		INT mm	EXT mm		Kg
STARBOX M BK	●	120 x 65 x 20	140 x 90 x 23	100	0,037

STARBOX M BK



Photos non contractuelles

STC/P

MALLETE DE PROTECTION ALUMINIUM

Mallettes de présentation avec structure en aluminium encadrant des panneaux en MDF recouverts de PVC. Elles sont équipées de charnières renforcées en acier, de deux serrures et d'une poignée. Garnies d'une mousse prédécoupée à l'intérieur et de mousse crantée sous le couvercle, elles vous permettront de protéger et de présenter vos produits.

ALUMINIUM CASE

Cases made of an aluminium frame with MDF boards covered with PVC sheets. They can be locked securely thanks to their 2 locks. Supplied with precutted foam and egg crated foam in lid.

STC 900 P



Coins renforcés
Reinforced corner



Coins renforcés
Reinforced corners



Fermeture à clés
Key locks



Patins caoutchouc
Rubber bump



Code	INT mm	EXT mm	MAX		Kg
STC 900 P	323 X 233 X 147	338 X 248 X 162	8 kg	1	1,20
STC 901 P	305 x 205 x 70	320 x 220 x 85	10 kg	1	1,15
STC 911 P	363 X 243 X 77	380 x 260 x 90	12 kg	1	1,30
STC 931 P	440 X 315 X 137	455 x 330 x 152	15 kg	1	1,40
STC 961 P	503 X 263 X 87	520 x 280 x 102	15 kg	1	2,40
STC 981 P	1003 X 303 X 97	1020 x 320 x 112	15 kg	1	4,40
STC 1908 P	457 X 315 X 155	482 X 340 X 205	15 kg	1	4,50
STC 2410 P	585 X 405 X 192	610 X 430 X 242	15 kg	1	6,40

TEK

MALLETE DE PRÉSENTATION STANDARD

Mallettes fabriquées en polypropylène et munies de 2 fermetures sur l'avant. Une mousse de calage est disponible, mais vous pouvez nous consulter pour vos projets d'usinage de mousse.



Caractéristiques

- Mallette de présentation
- Fermetures de sécurité
- Personnalisation (couleur, logo)
- Fabriqué en polypropylène

Technical characteristics

- Packaging case
- Safety front locks
- Customization (color, logo)
- Made of polypropylene

Code	L x l x H mm INT	L x l x H mm EXT		Kg
TEK 2002	228 x 136 x 42	235 x 185 x 48	24	0,22
TEK 2003	244 x 161 x 66	255 x 210 x 72	10	0,31
TEK 2004	261 x 170 x 77	275 x 230 x 83	6	0,38
TEK 2007	326 x 222 x 77	340 x 275 x 83	6	0,53
TEK 2007S*	326 x 222 x 50	340 x 275 x 56	9	0,46
TEK 2007M*	326 x 222 x 63	340 x 275 x 70	7	0,47
TEK 2008*	326 x 222 x 116	340 x 275 x 123	4	0,62
TEK 2009*	326 x 222 x 156	340 x 275 x 162	3	0,80
TEK 2011	379 x 234 x 100	395 x 295 x 106	5	0,71
TEK 2017*	434 x 289 x 100	450 x 360 x 106	5	1,00
TEK 2018*	434 x 289 x 116	450 x 360 x 123	5	1,09
TEK 2019	434 x 289 x 132	450 x 360 x 140	4	1,18

(*) Sur commande / Special order

STANDARD PACKAGING CASE

Polypropylene cases built to pack your products in a professional way. Available in black/red and other colors as special order. Cases can be supplied with standard foam or custom cut foam. Contact us.



MOUSSE DE CALAGE PROTECTION FOAM

Code	Pour / For	L x l x H mm EXT		Kg
2SE0215	TEK 2002	235 x 160 x 20	12	0,014
2SE0315	TEK 2003	250 x 180 x 20	10	0,023
2SE0415	TEK 2004	265 x 200 x 20	10	0,022
2SE0715	TEK 2007-08-09	325 x 250 x 20	12	0,027
2SE1125	TEK 2011	380 x 265 x 30	8	0,076
2SE1935	TEK 2017-18-19	435 x 320 x 45	4	0,154

HEAVY

MALLETTE HAUTE RÉSISTANCE

- Mallette de présentation industrielle
- Fermetures sur l'avant
- Personnalisation (couleur, logo)
- Trolley en option
- Fabriqué en polypropylène

HEAVY DUTY PACKAGING CASE

- Heavy duty packaging case
- Front locks
- Customization (color, logo)
- Trolley as option
- Made of polypropylene

Fermetures sur l'avant
Front locks



HEAVY 4014



2 HM 410



TRH 40 B

Code	L x l x H mm INT	L x l x H mm EXT	LITRE		Kg
HEAVY 4001	280 x 195 x 70	300 x 275 x 82	-	7	0,77
HEAVY 4002*	280 x 195 x 100	300 x 275 x 110	-	5	0,88
HEAVY 4003*	280 x 195 x 130	300 x 275 x 140	-	4	1,00
HEAVY 4010	360 x 228 x 90	390 x 310 x 102	8	6	1,16
HEAVY 4012	360 x 228 x 135	390 x 310 x 147	12	4	1,34
HEAVY 4014*	360 x 228 x 180	390 x 310 x 192	16	3	1,53
HEAVY 4028	459 x 319 x 110	500 x 420 x 125	17	1	2,36
HEAVY 4032*	459 x 319 x 160	500 x 420 x 175	34	1	2,70
HEAVY 4036*	459 x 319 x 210	500 x 420 x 225	32	1	3,04
HEAVY 4040	528 x 368 x 130	575 x 470 x 145	27	1	3,10
HEAVY 4044	528 x 368 x 180	575 x 470 x 205	39	1	3,50
HEAVY 4048*	528 x 368 x 250	575 x 470 x 270	51	1	3,95
HEAVY 4054*	622 x 442 x 220	665 x 562 x 250	-	1	4,60

* Sur stock en noir / Black in stock

MOUSSE DE CALLAGE (LOT DE 2) ET TROLLEY PROTECTION FOAM (SET OF 2) AND TROLLEY

Code	Pour / For	L x l x H mm EXT		Kg
2 HM 400	-	280 x 200 x 15	2	0,014
2 HM 410	-	370 x 240 x 15	2	0,023
2 HM 420	-	459 x 319 x 15	2	0,022
2 HM 440	-	528 x 368 x 15	2	0,027
TRH 40 A	HEAVY 4028 / 4040	TROLLEY	1	0,076
TRH 40 B	HEAVY 4032/4036/ 4044/4048/4054	TROLLEY	1	0,154



CASIER PLASTIQUE

Casiers en plastique pour le rangement des accessoires. Les tiroirs transparents (avec porte étiquette) sont équipés de séparateurs amovibles. Ils sont munis d'une poignée rabattable pour un transport facile.

PLASTIC CABINET

Plastic cabinets to store small parts and accessories. Supplied with transparent drawers (with label holder), dividers and foldable handle.



3/11



Poignée rabattable intégrée
Foldable handle

Porte étiquette
Label holder



5/27



Peut se fixer au mur
Can be wall mounted



7/43

Caractéristiques

- Fabriqué en polypropylène
- Armature plastique
- Tiroirs polypropylène
- Poignée de transport
- Porte étiquette
- Séparateurs intégrés amovibles
- Accroche murale

Specifications

- Made of polypropylene
- Plastic cabinet
- Polypropylene drawers
- Carrying handle
- Label holder
- Removable dividers included
- Fixation to the wall

Code	Quantité	L x l x H mm	Poids (Kg)
3/11	7	320 X 150 X 210	1,150
5/27	15	320 X 150 X 330	1,700
7/43	23	320 X 150 X 450	2,300

Code	Quantité	L x l x H mm	Poids (Kg)
3/11	7	320 X 150 X 210	1,150
5/27	15	320 X 150 X 330	1,700
7/43	23	320 X 150 X 450	2,300



SINGLE

CASIER MÉTAL

Casiers en métal livrés avec des tiroirs en polypropylène de différentes dimensions pour s'adapter à vos besoins. Ils permettront de ranger, trier, organiser les établis des professionnels et bricoleurs.

STEEL CABINET

Steel cabinets supplied with 3 different sizes of polypropylene drawers to fit your need. Thanks to their high storage capacity you will be able to store your working accessories.

8848 SINGLE



Porte étiquette
Label holder

A : 50 x 140 x 36 mm

B : 140 x 140 x 60 mm

C : 280 x 140 x 60 mm

8535 SINGLE



8560 SINGLE



8118 SINGLE

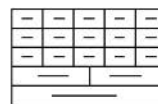

8535 SINGLE

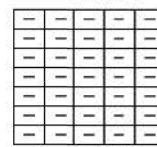

8640

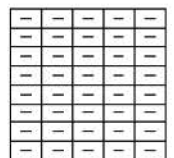

8738 SINGLE

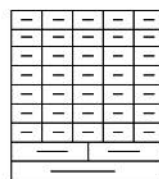

8560 SINGLE

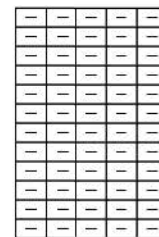

8848 SINGLE

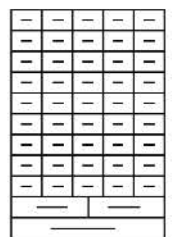

Séparateurs / Dividers



- S 850 SB : 50 x 30 mm
- S 8270 SB : 132 x 50 mm

Caractéristiques

- Casier métal
- Tiroirs polypropylène

Specifications

- Steel cabinet
- Polypropylene drawers

Code		L x l x H mm		Kg
8118 SINGLE	18	310 x 150 x 290	1	2,350
8535 SINGLE	35	310 x 150 x 330	1	3,000
8738 SINGLE	38	310 x 150 x 470	1	3,900
8848 SINGLE	48	310 x 150 x 550	1	4,700
8560 SINGLE	60	310 x 150 x 550	1	4,600

MALLETTE AVEC GODETS CASE WITH INSERTS



HANDY 32

Avec / with 4 x 31/16



MALLETTE AVEC GODETS

Boîtes de rangement fabriquées en polypropylène et disposant de godets amovibles pour le rangement de vos accessoires. Elles sont munies d'une poignée de transport et d'un couvercle transparent alvéolé qui sécurisera le contenu durant le transport. Le modèle 31/16 peut être intégré dans le caisson de transport HANDY 32.

CASE WITH INSERTS

Boxes made of polypropylene and designed to store accessories into removable inserts. The transparent alveolate lid will secure the contents during transport.





31/16 = 10 x A + 5 x B + 1 x C
41/24 = 9 x A + 10 x B + 5 x C



A : 50 x 50 x 50 mm

B : 50 x 100 x 50 mm

C : 100 x 100 x 50 mm

Code		L x l x H mm		Kg
31/16 41/24	16 24	300 x 255 x 55 400 x 370 x 58	18 12	0,550 1,220
HANDY 32	4 x 31/16	320 x 280 x 300	1	3,200



BOITE À COMPARTIMENTS

- Compartiments fixes et variables
- Séparateurs amovibles
- Fabriqué en polypropylène

COMPARTMENTS BOX

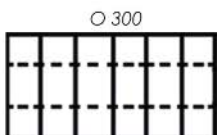
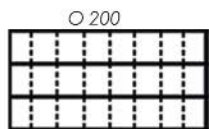
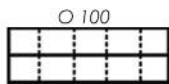
- Fixed and adjustable compartments
- Removable dividers
- Made of polypropylene



Code		L x l x H mm		Kg
○ 100	8	130 x 100 x 30	12	0,070
○ 200	21	200 x 150 x 40	24	0,210
○ 300	15	280 x 200 x 50	6	0,380



○ 300



○ 200



○ 100

W SÉRIE



MALLETE À GODETS

Mallettes au design novateur légères et ultra résistantes. Fabriquées en polypropylène, elles possèdent une double paroi renforcée ainsi qu'un couvercle alvéolé en polycarbonate. Ce couvercle permet de sécuriser le transport, il se verrouille grâce à des fermetures sécurisées. Elles sont livrées avec des godets munis de couvercles. Autres coloris sur demande.



- A : 52 x 52 x 50 mm
- B : 105 x 52 x 50 mm
- C : 160 x 52 x 50 mm
- D : 210 x 55 x 50 mm
- E : 105 x 105 x 50 mm

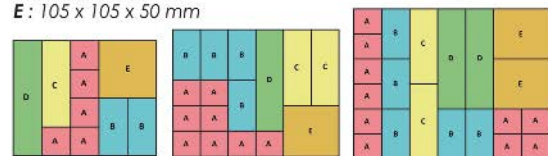

Caractéristiques

- Double paroi renforcée
- Couvercle polycarbonate alvéolé
- 2 fermetures sécurisées
- Poignée confort
- Large verrous latéraux
- Godets avec couvercle
- Fabriqué en polypropylène

Specifications

- Double lining
- Alveolate polycarbonate lid
- 2 secure locks
- Comfort handle
- Wide side locks
- Inserts with lid
- Made of polypropylene

CASE WITH INSERTS

These new design professional cases are built to be resistant and light. Made with a polypropylene bottom they combine a double lining and an alveolate polycarbonate lid and secure locks. They are supplied with inserts with lids. Other colors on request.

Couvercle polycarbonate en nid d'abeille
Polycarbonate lid



Code		L x l x H mm EXT	L x l x H mm INT		Kg
W 185-10	10	325 x 275 x 70	275 x 220 x 50	6	1,10
W 285-16	16	375 x 325 x 70	330 x 275 x 50	6	1,40
W 385-21	21	420 x 370 x 70	380 x 330 x 50	6	2,10



JAP

BOITE À COMPARTIMENTS

- Coins renforcés en PVC
- Compartiments fixes et variables
- Disponible en rouge et bleu
- Séparateurs amovibles
- Fabriqué en polypropylène

COMPARTMENTS BOX

- Heavy duty PVC corners
- Fixed and adjustable compartments
- Available in red and blue
- Removable dividers
- Made of Polypropylene

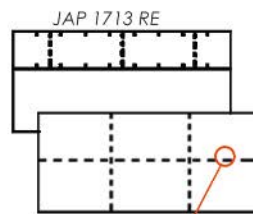
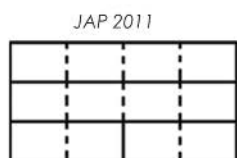
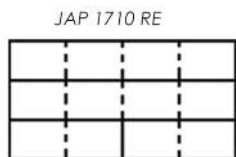
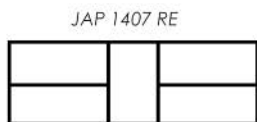

Séparateurs amovibles
Removable dividers

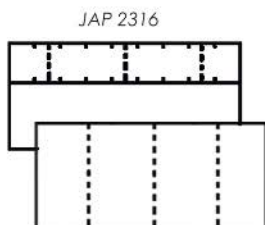

Code		L x l x H mm		Kg
JAP 1407		140 x 80 x 30	20	0,05
JAP 1407 RE		140 x 80 x 30	20	0,05
JAP 1710		170 x 100 x 30	20	0,09
JAP 1710 RE		170 x 100 x 30	20	0,09
JAP 1713		170 x 130 x 60	10	0,16
JAP 1713 RE		170 x 130 x 60	10	0,16
JAP 2011		200 x 110 x 30	20	0,13
JAP 2011 RE		200 x 110 x 30	20	0,13
JAP 2316		240 x 170 x 60	8	0,33
JAP 2316 RE		240 x 170 x 60	8	0,33

MALLETTE AVEC SÉPARATEURS AMOVIBLES BOX WITH DIVIDERS

MALLETTE DE RANGEMENT

Mallettes de rangement fabriquées en polypropylène et disposant de séparateurs amovibles vous permettant de ranger vos accessoires. Elles sont munies d'une poignée de transport et d'un couvercle transparent alvéolé.

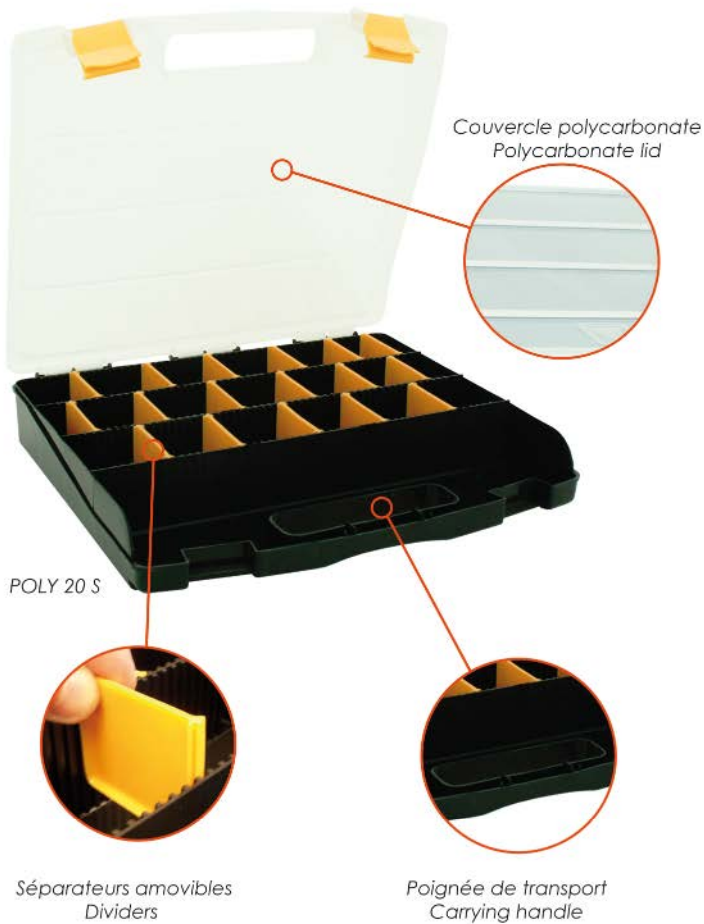

CASE WITH DIVIDERS

Cases made of polypropylene and designed to store your accessories. They are supplied with dividers, the transparent lid will secure the content during transport.



Code		L x l x H mm		Kg
POLY 3 S	12	290 x 180 x 40	12	0,250
POLY 10 S	18	310 x 285 x 50	6	0,620
POLY 20 S	1	375 x 310 x 65	6	0,980

BOITE AVEC COMPARTIMENTS FIXES BOX WITH FIXED COMPARTMENTS



BOITE DE RANGEMENT

Série de boîtes de rangement fabriquée en polypropylène et disposant de compartiments fixes. Elles sont équipées d'une poignée de transport et de 2 fermetures.

LIGHT DUTY STORAGE CASE

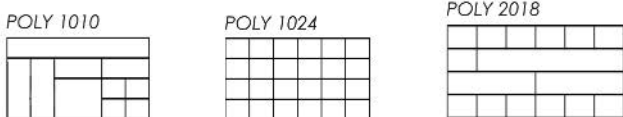
Light duty storage case made of polypropylene and equipped with fixed compartments, ergonomic handle and 2 locks.



Code		L x l x H mm		Kg
POLY 1010	10	310 x 285 x 55	6	0,520
POLY 1024	24	310 x 285 x 55	12	0,600

Jusqu'à épuisement des stocks





PANNEAU D'ATELIER

Panneau d'atelier fabriqué en polypropylène permettant le rangement des outils et des accessoires de bricolage. Il est livré avec bacs, porte-outils et fixations.

WALL PANEL

Wall panel made of polypropylene to store tools and accessories. Supplied with bins, holders and fixations.

80 x 85 x 65 mm



x 16

130 x 85 x 65 mm



x 8

180 x 85 x 65 mm



x 4



420 x 590 mm

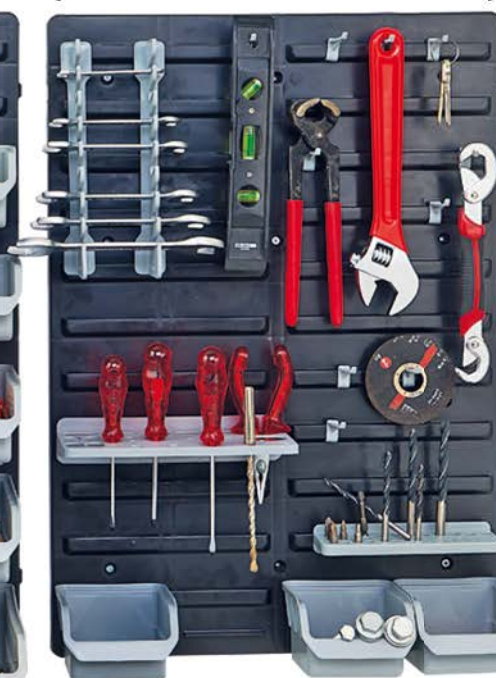

x 10

x 2

x 1

x 1

DP 01

Caractéristiques

- Panneau pour atelier en polypropylène
- Livré avec vis et chevilles
- Livré sans outils

Specifications

- Polypropylene wall panel
- Delivered with screws and plug
- Sold without tools

Code	L x H mm		Kg
DP 01	840 x 590	1	2.70

RANGEMENT OUTILS SOFT TOOL STORAGE

CARACTÉRISTIQUES TOOLROLLEY

- Sac à dos sur roulettes
- Bretelles 85mm
- Hauteur totale 1M déplié
- Poignée télescopique
- 2 roulettes avec housse

TOOLROLLEY SPECIFICATIONS

- Soft back pack on wheels
- Straps 85 mm
- Total height 1M unfolded
- Retractable handle
- 2 nylon wheels with cover

Code	L x l x H mm		Kg
TOOLROLLEY	360 x 200 x 500	1	2,450



TOOLROLLEY

CARACTÉRISTIQUES TOOLBOX

- Boîte à outils tissu
- Poignée confortable
- 12 poches extérieures
- Fond ABS renforcé et étanche

TOOLBOX SPECIFICATIONS

- Soft toolbox
- Soft touch handle
- 12 pockets on the side
- Heavy duty ABS bottom

Code	L x l x H mm		Kg
TOOLBOX	420 x 210 x 230	6	1,450



TOOLBOX

CARACTÉRISTIQUES TOOLBAG

- Sacoches à outils tissu
- 29 porte outils
- 1 pochette détachable
- Bandoulière réglable
- 2 poches extérieures
- Vendu sans outils

TOOLBAG SPECIFICATIONS

- Soft tool case
- 29 tool holders
- 1 removable pocket
- Adjustable strap
- 2 side pockets
- Sold without tools

Code	L x l x H mm		Kg
TOOLBAG	365 x 265 x 70	4	0,840



TOOLBAG

CARACTÉRISTIQUES TBELT1

- Ceinture à outils tissu
- 14 poches
- 2 anneaux métal
- 3 anneaux sangles
- Ajustable à la taille

TBELT1 SPECIFICATIONS

- Soft tool belt
- 14 pockets
- 2 steel rings
- 3 strap rings
- Adjustable

Code	L x l x H mm		Kg
TBELT1	1 taille / 1 size	20	0,600



TBELT1

BOÎTE À OUTIL SÉRIE PROFESSIONNELLE PROFESSIONAL TOOLBOX

SM SÉRIE

BOITE À OUTILS SÉRIE PROFESSIONNELLE

Boîtes à outils fabriquées en polypropylène et munies de fermetures sécurisées ainsi que d'une poignée ergonomique rabattable. Elles sont livrées avec un plateau intérieur amovible.



SM 01

Fermeture sécurisée
Secure lock

SM 02/03

Caractéristiques

- Boîte à outils
- Plateau amovible
- 2 verrous acier
- Fabriqué en polypropylène

Specifications

- Tool box
- Removable tray
- 2 steel locks
- Made of polypropylene

PROFESSIONAL TOOLBOX

Toolboxes made of polypropylene and supplied with secure locks and an ergonomic handle. A removable tray is included inside to store tools.



Poignée de transport
Carrying handle

Code	Size	L x l x H mm		Kg
SM 01*	16"	395 x 210 x 177	12	1,200
SM 02*	19"	458 x 233 x 247	9	1,800
SM 03*	26"	535 x 276 x 267	6	2,500

* Sur commande / On request

BOÎTE À OUTIL STANDARD TOOLBOX

ML / PO SÉRIE

BOITE À OUTILS STANDARD

Boîtes à outils fabriquées en polypropylène et livrées avec un plateau amovible. Le dessus du couvercle est muni de compartiments permettant de ranger de petits accessoires. Elles peuvent être verrouillées par un cadenas (non fourni).



PO 05
PO 08 RS

Fermeture sécurisée par cadenas
Secure lock by padlock

Rangement sur le couvercle
Lid with compartments

PO 06
PO 07

STANDARD TOOLBOX

Toolboxes made of polypropylene and supplied with a removable tray. The transparent lid is made with compartments to store small parts. Secure lock by padlock (not supplied).



ML 26

Fermetures sécurisées
Secure locks

Code	Size	L x l x H mm		Kg
PO 06	13"	320 x 150 x 135	12	0,500
PO 07	16"	410 x 200 x 180	12	1,000
PO 05	19"	480 x 230 x 230	9	1,600
PO 08 RS	22"	555 x 290 x 265	6	2,500

Code	Size	L x l x H mm		Kg
ML 26*	26"	607 x 277 x 314	1	3,000

* Sur commande / On request



MALLETTE PORTE-OUTILS ALUMINIUM

Mallettes fabriquées 100 % en aluminium et équipées de rangements. Ultra résistantes, elles sont munies de charnières en acier, d'une poignée ergonomique et d'une sangle de transport. La fermeture se fait par deux serrures à clé.

ALUMINIUM SERVICE CASE

Aluminium service cases provided with tool organizers. Made to be resistant their hinges are made of steel. They have an ergonomic handle and a carrying belt is supplied. Can be closed with 2 locks with key.



Caractéristiques

- Fabriqué 100% en aluminium
- Charnières acier
- Fermetures à clés
- 6 compartiments dans le fonds
- MC 1805 : 1 plateau
- MC 1806/1808 : 2 plateaux
- Séparateurs amovibles
- Rangement outillage

Specifications

- Made of 100 % aluminium
- Steel hinges
- Secure locks
- 6 compartments at the bottom
- MC 1805 : 1 tray
- MC 1806/1808 : 2 trays
- Removable dividers
- Tool organizers

Code	L x l x H mm EXT	L x l x H mm INT		Kg
MC 1805*	440 x 300 x 125	425 x 285 x 100	1	2,20
MC 1808*	440 x 300 x 200	425 x 285 x 185	1	2,50

Vendu sans outils - Sold without tools * Sur commande / On request

Caractéristiques

- Charnières en acier
- 2 Fermetures
- Avec séparateurs amovibles (STC921/931)
- 4 tiroirs télescopiques (STC944)
- Large espace dans les compartiments
- Parois MDF recouvertes d'aluminium

Specifications

- Steel hinges
- 2 locks
- With removable dividers (STC921/931)
- Large space in compartments
- 4 telescopic drawers (STC944)
- Wall MDF covered aluminium

Vendu sans outils - Sold without tools

Code	L x l x H mm INT	L x l x H mm EXT	MAX		Kg
STC 921	410 x 290 x 113	425 x 305 x 125	9 kg	5	2,20
STC 944	350 x 205 x 238	365 x 220 x 250	13 kg	1	2,80

Vendu sans outils - Sold without tools

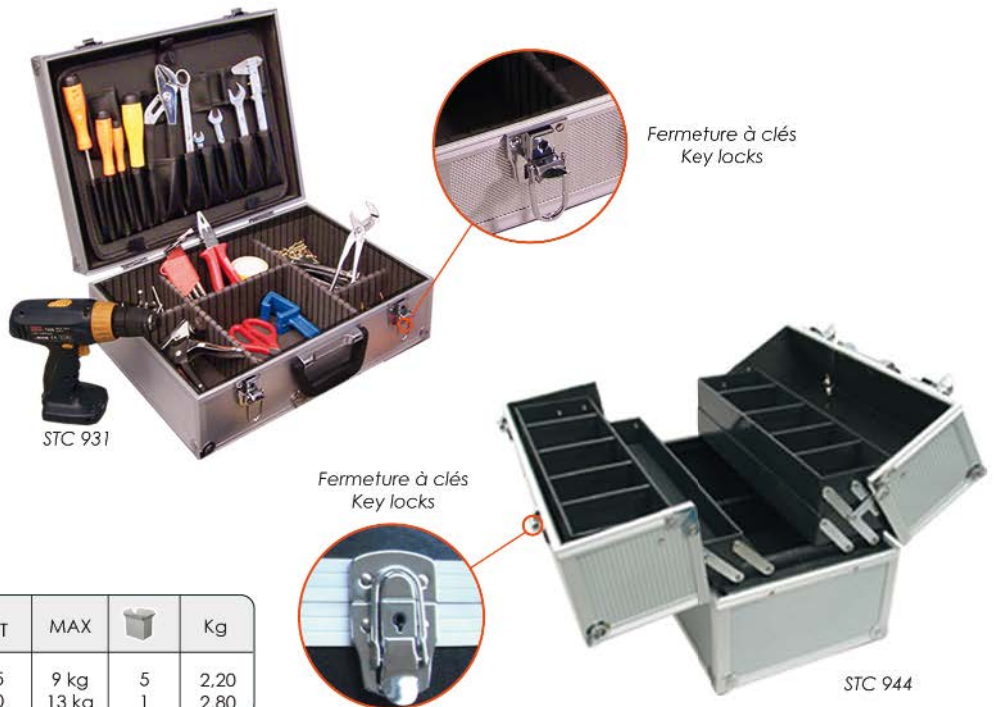

RMZ

CHARIOT INDUSTRIEL

Chariot industriel avec structure en acier et plateau en polypropylène. Les roues sont fabriquées en caoutchouc, 2 fixes et 2 pivotantes. Il est muni de 4 patins anti-dérapants et d'un frein (en option pour le RMZ 910). Le RMZ 740 peut supporter une charge de 150 Kg tandis que le RMZ 910 supporte une charge de 300 Kg et est équipé de 2 poignées de transport.



NOUVEAU / NEW
Option freins / Optional brake

RMZ 910

Caractéristiques

- Chariot de transport pliant
- Poignées ergonomiques
- Patins anti-dérapant
- 2 roues pivotantes
- 2 roues fixes
- Option frein (RMZ 910)
- Roues caoutchouc
- Lavable / Anti rouille
- Fond renforcé
- Fabriqué en polypropylène
- A assembler

Specifications

- Foldable transport trolley
- Ergonomic handles
- Non-slipping grips
- 2 swivelling wheels
- 2 fixed wheels
- Optional brake (RMZ 910)
- Rubber wheels
- Washable / Rust proof
- Strengthened bottom
- Made of polypropylene
- To assemble

INDUSTRIAL TROLLEY



Industrial truck made of steel and polypropylene. Wheels are manufactured out of rubber, 2 fixed, 2 swivelling. Non-skid carriage provided with 4 blocks and a brace (optional for RMZ 910). RMZ 740 can load 150 Kg whereas RMZ 910 can load 300 kg and is equipped with 2 carrying handles

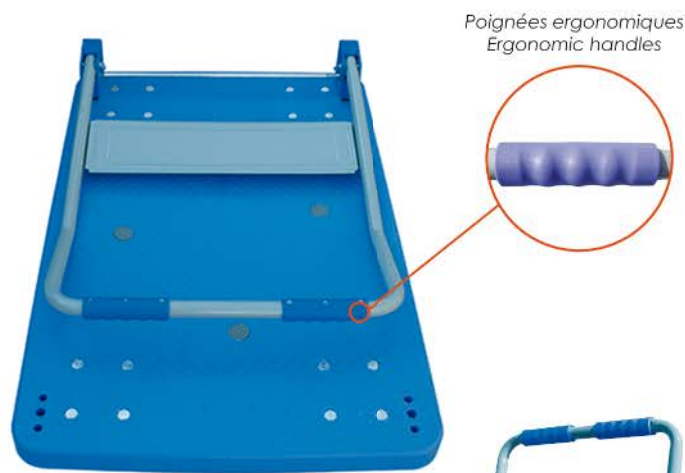

Poignées ergonomiques
Ergonomic handles

RMZ 740



RMZ 740

Code	Ø Roues Wheels	L x l x H mm	Max KG		Kg
RMZ 740	ø 100 mm	720 x 490 x 825	150	1	10,00
RMZ 910	ø 125 mm	900 x 600 x 900	300	1	14,00

CHARIOT INDUSTRIEL INDUSTRIAL TROLLEY



CHARIOT INDUSTRIEL INDUSTRIAL TROLLEY



Roues et poignée rabattues
Wheels and handle folded



- Plateau polypropylène
- Structure acier
- Chariot pliant
- Poignées de transport
- Fond renforcé
- Roues rabattables
- Extra plat

- Polypropylène tray
- Steel structure
- Foldable trolley
- Transport handle
- Strengthened bottom
- Folding wheels
- Extra flat

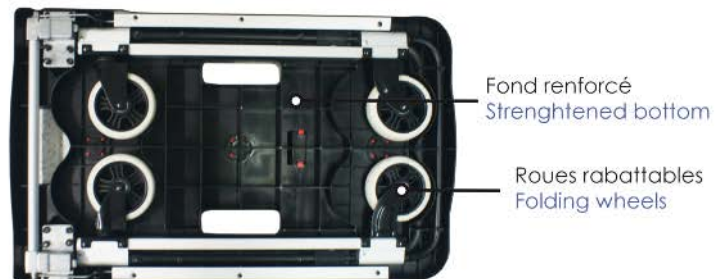

REF	DIM. PLIÉ (mm)	DIM. DÉPLIÉ (mm)	MAX (KG)	KG
RMP 600 *	680 x 410 x 80	680 x 410 x 920	130	6,40
RMP 900	800 x 520 x 100	800 x 520 x 870	200	11,00

* Poignée retractable / foldable handle

RMP TROLLEY



- Aluminium et PP
- Entièrement pliable
- Poignées de transport
- Bavette 25 cm
- Adaptable en chariot ou en diable
- Stockage facile

- Aluminium and PP
- Fully foldable
- Transport handles
- 25 cm bib
- Adaptable as trolley or handtruck
- Easy storage

Poignée de transport
Transport handle

Bavette 25 cm
Bib



Roue 5" / 12,7 cm
Wheel

Roues et poignée rabattues
Wheels and handle folded



REF	DIM. PLIÉ (mm)	DIM. DÉPLIÉ (mm)	DIM. DÉPLIÉ (mm)	MAX (KG)	MAX (KG)	KG
RMP TROLLEY	390 x 640 x 120	780 x 410 x 900	450 x 460 x 1100	137	68	7,40
		chariot	diable	chariot	diable	
		trolley	handtruck	trolley	handtruck	



136
KG





Roue 3,5" / 9 cm
Wheel



Roues et poignée rabattues
Wheels and handle folded

- + Aluminium et PP
- + Entièrement pliable
- + Poignées de transport
- + Peut être utilisé avec la référence BP 560
- + Stockage facile

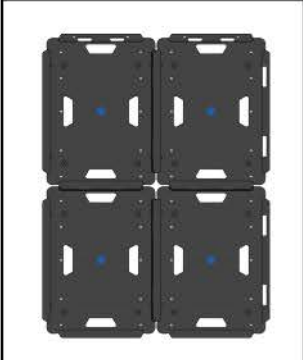
- + Aluminium and PP
- + Fully foldable
- + Transport handles
- + Can be used with the reference BP 560
- + Easy storage





BP 560



REF	DIM. PLIÉ (mm)	DIM. DÉPLIÉ (mm)	MAX (KG)	KG
RP 602	600 x 450 x 77	600 x 450 x 167	136	4,90



30
KG



Poignée de transport
Transport handle

Entièrement plié
Fully folded

- + Fabriqué en PP
- + Entièrement pliable
- + Empilable
- + Peut être utilisé avec la référence RP 602
- + Stockage facile

- + Made of PP
- + Fully foldable
- + Stackable
- + 25 cm bib
- + Can be used with the reference RP 602

REF	DIM. PLIÉ (mm)	DIM. DÉPLIÉ (mm)	MAX (KG)	KG
BP 560 BP 561 (x 5)	560 x 400 x 75	560 x 410 x 265	30	1,90 9,50

RP SÉRIE



PLATEAU POLYPROPYLENE

Plateaux de manutention en polypropylène. Les roues sont fabriquées en caoutchouc. Ils sont munis de patins anti-dérapants et de poignées de transport (pour le RP 601). Possibilité de mettre une corde pour tirer le plateau. Il est possible de combiner plusieurs RP 601 pour former un grand plateau.

POLYPROPYLENE TRAY

Handling tray made of polypropylene. Wheels are made of rubber. Provided with 4 slip resistant pads and handles of transport (only RP 601). Possibility to put a rope to draw the plate. It's possible to combine RP 601 to make a bigger tray.

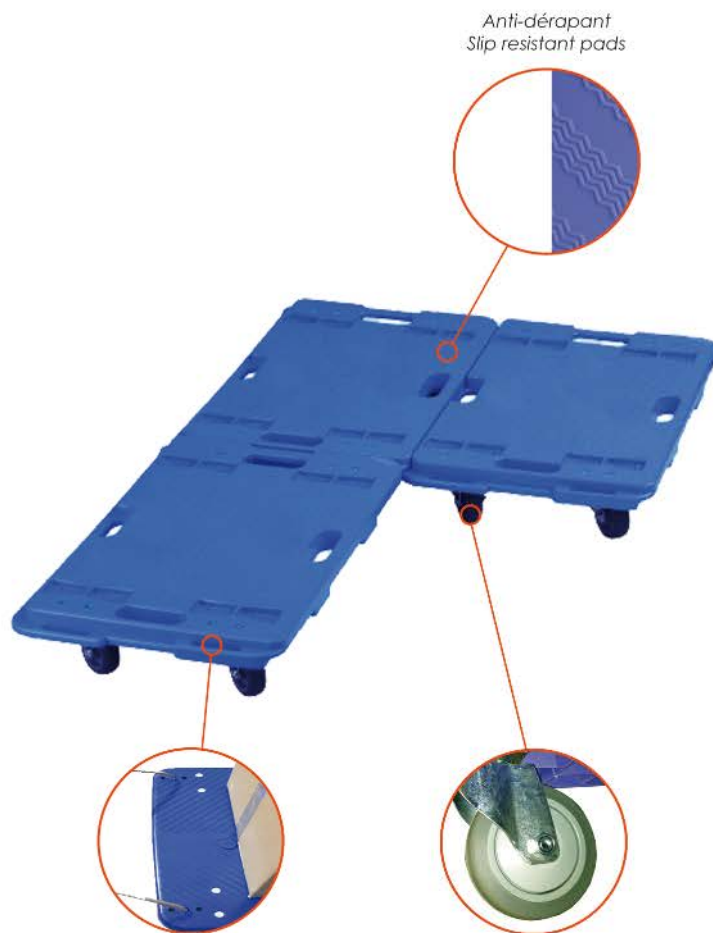

Caractéristiques

- Plateau de transport roulant
- Patins anti-dérapant
- Superposable (RP 601)
- Passages de corde
- Poignée de transport (RP 601)
- Lavable / Anti rouille
- Fabriqué en polypropylène

Specifications

- Transport tray
- Non-slipping grips
- Stackable (RP 601)
- Holes for rope
- Carrying handle (RP 601)
- Washable / Rust proof
- Made of polypropylene

Code	Ø Roues Wheels	L x l x H mm	Max KG		Kg
RP 601	ø 75 mm	600 x 400 x 125	180	1	3.60



RMC

CHARIOT PROFESSIONNEL

Pour les livraisons ou pour le transport de matériel. Les RMC sont fabriqués en acier et sont équipés de 4 roues en caoutchouc (dont 2 pivotantes).



RMC 740



INDUSTRIAL TROLLEY



For delivery or to carry day to day material, RMC are made of steel with 4 rubbers wheels (2 swivels wheels).



RMC 910

Fond renforcé
Strengthened bottom



Caractéristiques

- Chariot de transport pliant
- Roues caoutchouc
- Tapis anti-dérapant
- Fabriqué en acier laqué
- A assembler

Specifications

- Foldable transport trolley
- Rubber wheels
- Non-slipping surface
- Made of acquerred steel
- To assemble

Code	Ø Roues Wheels	L x l x H mm	Max KG		Kg
RMC 740	ø 100 mm	740 x 480 x 740	150	1	8,00
RMC 910	Ø 125 mm	915 x 600 x 800	300	1	9,00

DIABLE DE MANUTENTION HANDLING TRUCK



DIABLE 3 ROUES HANDLING TRUCK 3 WHEELS



- Aluminium
- Max 120 kg sur sol plat
- Max 35 kg en escalier
- Bavette : 270 x 385 mm
- Roues : Ø 100 mm

- Aluminium
- Max 120 kg on road
- Max 35 kg climbing stair
- Toe tray : 270 x 385 mm
- Wheels : Ø 100 mm

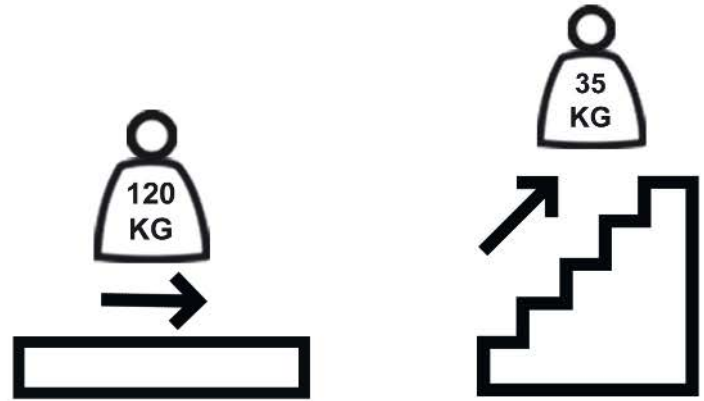

Ø 100 mm
Roues en polypropylène et bandage TPR
Polypropylene wheels and TPR wrapped



REF	DIM. PLIÉ (mm)	DIM. DÉPLIÉ (mm)	KG
RP 303 FOL	440 x 740 x 100	470 x 445 x 1020	4

RP



DIABLE MANUTENTION

Pour le transport de charges lourdes et encombrantes, nous proposons une gamme complète de diables. Le modèle RP 200 FIX possède 2 roues pneumatiques pour une utilisation industrielle, tandis que les modèles RP FOL sont des diables pliants et seront adaptés à une utilisation plus polyvalente.

HANDLING TRUCK

To carry heavy stuff we have developed a complete range of professional handling trucks. Made of steel with large pneumatic wheels, our RP 200 FIX will be the perfect industrial handling truck, whereas the folding trucks RP FOL are dedicated to general purpose.





Caractéristiques

- Armature aluminium (RP FOL)
- Diable pliant (RP FOL)
- Armature acier (RP 200 FIX)
- Roues pneumatiques (RP 200 FIX)

Specifications

- Made of aluminium (RP FOL)
- Foldable (RP FOL)
- Made of steel (RP 200 FIX)
- Pneumatic wheels (RP 200 FIX)

Code	L x l x H mm (1) Plié / folded	L x l x H mm (2) Monté / Mounted	Max KG		Kg
RP 45 FOL	690 x 380 x 55	970 x 350 x 380	50	1	2,70
RP 60 FOL	720 x 485 x 55	980 x 430 x 485	70	1	4,70
RP 200 FOL	790 x 490 x 63	1080 x 490 x 515	120	1	5,00

Code	L x l x H mm (2) Monté / Mounted	Max KG		Kg
RP 200 FIX	555 x 461 x 1100	200	1	9,00

COINS ROULANTS ROLLING CORNERS



COINS ROULANTS

Afin de vous aider dans le déplacement d'objets lourds et encombrants (machines, matériels ...) les coins roulants vous seront d'une aide précieuse. Le RP 01 G est vendu avec une valise de transport (disponible en sac également) tandis que le RP 250 est vendu avec un sac de transport.

ROLLING CORNERS

Bulky or heavy objects are difficult to handle, these rolling corners will be helpful. RP 01 G sell with a case (also available in bag) to carry, RP 250 sell with a bag to carry.

Caractéristiques

- Coins roulants
- Avec caoutchouc anti-dérapant
- Lot de 4
- Fabriqué en polypropylène (RP 250)
- Fabriqué en acier (RP 01 G)

Specifications

- Foldable handling truck
- With no slipping rubber
- Set of 4
- Made of polypropylene (RP 250)
- Made of steel (RP 01 G)

Code		EXT mm	A x B x C mm	Max KG		Kg
RP 01 G		245 x 245 x 70	145 x 145 x 50	4 x 150	1	7,20
RP 250		250 x 250 x 60	145 x 145 x 50	4 x 50	1	3,60

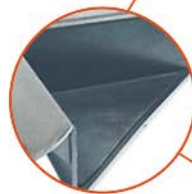
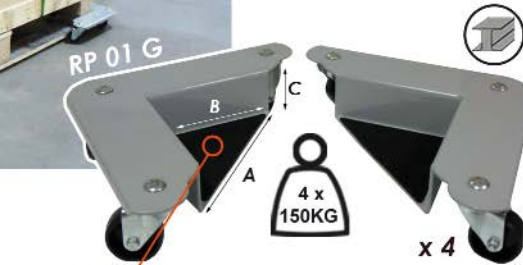

Caoutchouc anti-dérapant
No slipping rubber



Valise de transport
Transport case
(RP 01 G)



Sac de transport
Transport bag
(RP 250)

CAISSE PLIANTE FOLDABLE CRATE



CAISSE PLIANTE

Entièrement pliante et équipée d'une poignée télescopique, cette caisse sera un atout incontournable dans le transport d'objets. Résistance 35 Kg.

FOLDING HAND CART

This portable cart is an essential piece of equipment for people on the go! Durable rolling crate has a telescopic aluminum handle and folding sides that allows it to store compactly like a small briefcase.

Caractéristiques

- Caisse pliante
- Poignée télescopique
- Fabriqué en polypropylène

Specifications

- Foldable crate
- Telescopic handle
- Made of polypropylene

Code	L x l x H mm ouvert / open	L x l x H mm fermé / close	Max Kg		Kg
TROLLEY GP	420 x 400 x 380	420 x 400 x 80	35	1	3,00



TROLLEY GP

SERVANTE

SERVANTE POLYPROPYLÈNE

Servante double plateau en polypropylène. Armature en acier zingué sur des roues de diamètre 100 mm (2 roues fixes et 2 pivotantes sans freins). La capacité en charge par plateau est de 75 Kg. Ces plateaux sont équipés de 4 patins anti-dérapants et de bords latéraux anti-dérapants.

DOUBLE TRAY TROLLEY

Double tray trolley made of steel and polypropylene. Each tray can load 75kg. Wheels are made of rubber (2 fixed and 2 swivelling without brakes). Trays are equipped with slip resistant pads and side protections.



Caractéristiques

- Servante 2 niveaux
- Patins anti-dérapant
- Renforts latéraux
- Fabriqué en polypropylène/Acier zingué

Specifications

- Transport double tray
- Non-slipping grips
- Side protections
- Made of polypropylene/Zinc steel

Code	Ø Roues Wheels	L x l x H mm	Max KG		Kg
SERVANTE 300	ø 100 mm	485 x 720 x 950	150	1	17,00

CHARIOT COURRIER MAIL TROLLEY



Caractéristiques

- Chariot courrier ou de préparation
- 2 ou 3 paniers
- Paniers amovibles
- 2 roues freinées
- Fabriqué en acier galvanisé

Specifications

- Mail or preparation trolley
- 2 or 3 baskets
- Removable baskets
- 2 wheels with brake
- Made of galvanized steel

- A 425 x 325 x 125/170 mm
- B 460 x 450 x 100/150 mm
- C 460 x 450 x 110/200 mm

Code	Ø Roues Wheels	L x l x H mm	Max KG		Kg
MC 400	ø 75 mm	560 x 450 x 950	2 x 15 kg	1	8,00
MC 01	ø 75 mm	460 x 460 x 1050	3 x 15 kg	1	12,00

CORBILLE DE TRI ET DE CLASSEMENT STEEL BASKET

CORBILLE DE TRI ET DE CLASSEMENT

Des solutions simples pour le tri et le classement du courrier ou des dossiers. Les corbeilles sont équipées de porte-étiquettes et sont superposables. Il est possible de transporter les corbeilles grâce au chariot MC 200.

STEEL BASKET

Simple solution to sort out letters and files. Equipped with label holder and stacking devices. Now you can carry baskets thanks to MC 200 tray.

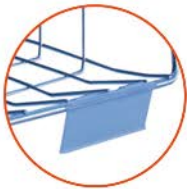

Porte-étiquette
Label holder

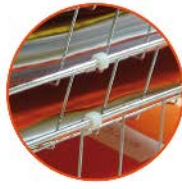

Crochets de superposition
Stacking hooks



Caractéristiques

- Corbeille de tri
- Avec porte-étiquette
- Fabriqué en Acier

Specifications

- Basket
- With label holder
- Made of steel

Code	L x l x H mm		Kg
COR 610	290 x 360 x 60	6	0,34
COR 1210	290 x 360 x 110	4	0,40
COR 1910	290 x 360 x 190	2	0,50
MC 200 *	-	1	6,50





DVD



DVD 1500



DVD 1000



Avec capuchons
With caps



DVD 01

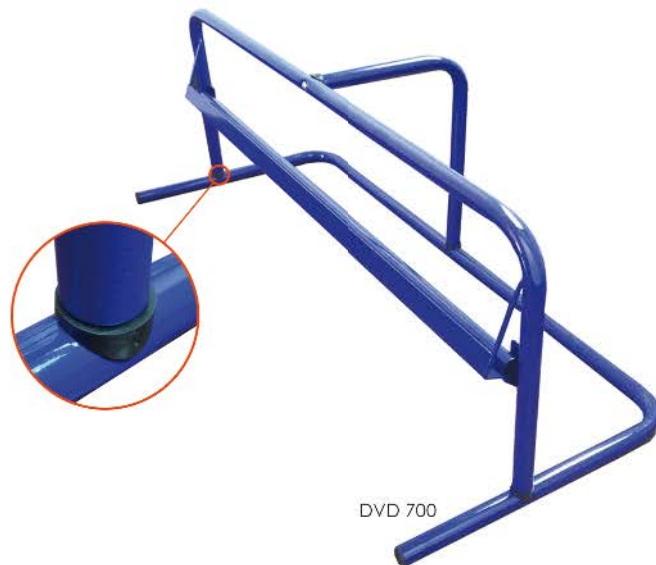

DVD 700

Option roulettes (dont 2 avec freins)
Wheels as option (2 with brake)



DVD 4 WH

Caractéristiques

- Dérouleur de papier
- Blocage par goupille
- Papier non inclus
- Fabriqué en acier

Specifications

- Paper dispenser
- Linches to stop the rolls
- Paper not included
- Made of steel

Code	L x l x H mm	Largeur rouleau Roll width		Kg
DVD 700	800 x 340 x 300	Ø 25-50 / 40-70 cm	1	3,45
DVD 1000	1360 x 370 x 450	Ø 35-80 / 100-120 cm	1	5,00
DVD 1500	510 x 510 x 1530	Ø 35-80 / 100-120 cm	1	16,00
DVD 4 WH *	Ø 75	-	1	2,00
DVD 01	-	50 mm	1	0,37

* 4 Roulettes pour DVD 1500 / 4 wheels for DVD 1500

DVD



SS 800



SS 800

110 / 130 L

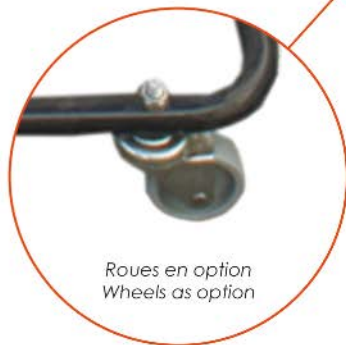

Roues en option
Wheels as option



SS WHEEL x 4



DVD 475 ST

DVD 40 SUP
(OPTION)



Support sac poubelle pour DVD 475 ST
Bin bag holder for DVD 475 ST

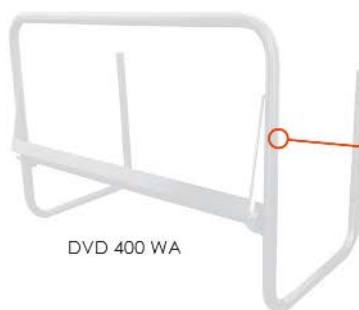

DVD 400 WA



Caractéristiques

- Support sac poubelle
- Pour sac 110/130 litres
- Roues en option
- Fabriqué en acier
- Livré sans sac

Specifications

- Trash bin
- Bags 110/130 litres
- Wheels as option
- Made of steel
- Without bag

Code	L x l x H mm		Kg
SS 800	560 x 440 x 800	1	2,80
SS WHEEL	Ø 25 mm	1	0,40

Caractéristiques

- Dérouleur de papier / sac poubelle
- Papier / sac poubelle non inclus
- Fabriqué en acier

Specifications

- Paper / bin bag dispenser
- Paper / bin bag not included
- Made of steel

Code	L x l x H mm	Largeur rouleau Roll width		Kg
DVD 400 WA	600 x 300 x 400	45 cm	1	2,30
DVD 475 ST	500 x 480 x 1000	45 cm	1	4,6
DVD 40 SUP	460 x 360	-	1	1,3

Index alphabétique
Alphabetical index

0-9		K		S	
2 SE 0215/.../ 2 SE 1935	32	KOFFPRO	20	SERVANTE 300	59
3/11	36			SM 01/02/03	46
5/27	36			SPACY	4
7/43	36	L		SPK	12
31/16	38			SS 800	62
41/24	38	LOGIC 23/.../191	26	SS WHEEL	62
8118/.../8560 SINGLE	37			STAR	5
				STARBOX	30
A		M		STC 921/931/944	47
A 100/.../1600	6	MAK 20/30	8	STC 900/.../2410 P	31
ALUD	25	MALLE S/.../XXL	22		
ALUR	24	MALLE WS/WM	23	T	
AP 32/40/84	10	MALLE W KIT	23	TBELT1	45
AR 03/04/05	9	MAS 10/20/30	8	TEK	32
ASP 32/40/84	10	MAT 20/30	9	TK 50/70/100	30
		MC 01/400	60	TOOL BAG	45
		MC 200	60	TOOL BOX	45
		MC 1805/.../1808	47	TOOL TROLLEY	45
		ML 26	46	TR	7
B				TROLLEY GP	58
BP 320/223/60 BL	14	O			
BP 560/561	53	O 100/200/300	38	W	
		OFFICE 50/74	26	W 185/.../385	39
C				WAT 18/.../1350 TR	29
COR 610/1210/1910	60	P		WAT 130/.../515	28
		P 6420-00	15		
D		PM 02/04	30		
DP 01/02	44	PO 06/07/05/08 RS	46		
DSW	17	POLY 3 S/.../30 S	41		
DVD	61 - 62	POLY 1010/.../2018	41		
		R			
E		RMC 740/910	55		
E 3201/4301/6401	13	RMP 600/900	51		
E3211	13	RMP TROLLEY	52		
E 4312/.../4332	13	RMZ 740/910	50		
E 6412/.../6440	13	RP 01 G	58		
E 6420-00/6432-00	15	RP 200 FIX	57		
EP 4323/6423/6333	16	RP 250	58		
EPC 6433	16	RP 303 FOL	56		
E 8888	13	RP 601/900	54		
		RP 602	53		
H		RP FOL	57		
HANDY 32	38				
HEAVY 4001/.../4054	33				
J					
JAP 1407/.../2316	40				