



CATALOGUE
QUINCAILLERIE



CABLE & FIL DE FER - CABLE - CABO - KABEL

13

CÂBLE - CABLE - CABO - KABEL	P.14
CORDE À LINGE - CLOTHES LINE - CUERDA TENDER - CORDA À ROUPA - WASLIJN	P.15
FIL DE FER - STEEL WIRE - ALAMBRE - ARAME - DRAAD	P.16
RAIDISSEUR - WIRE STRAINER - TENSOR PARA ALAMBRE - ESTOCADOR PARA ARAME - KABEL SCHOTJE	P.17
CHAPEAU POUR POTEAU - POST CAP - SOMBRERETE DE ACERO - CHAPEU DE AÇO - STALEN HAT	P.17

CHAÎNES - CHAIN - CADENA - CADEIA - KETTING

19

CHAÎNE MÉTAL SOUDÉE - WELDED METAL CHAIN - CADENA EN METAL SOLDADO CADEIA DE METAL SOLDU - METALEN KETTING	P.20
CHAÎNE DÉCORATIVE - ORNAMENTAL CHAIN - CADENA DECORATIVA CADEIA DECORATIVA - ORNAMENTAL KETTING	P.23
CHAÎNE PLASTIQUE - PLASTIC CHAIN - CADENA PLÁSTICA - CADEIA PLÁSTICA - PLASTIC KETTING	P.24

CORDAGES & FICELLES - ROPE - CUERDA - CORDA - TOUW

25

CORDE - ROPE - CUERDA - CORDA - TOUW	P.26
DRISSE - HALYARD - DRIZA - CABO - VAL	P.29
FICELLE - TWINE - CORDEL - FIO - TOUWJTE	P.32

ARRIMAGE

35

SANDOW - BUNGEE CORD - EXTENSOR - TENSOR - BUNGEE KOORD	P.36
SANGLE - RATCHET TIE DOWN - CORREA - CORREIA - SPANRIEM	P.38
ELINGUE - SLING - ESLINGA - LINGA - STROP	P.40
AGGRIPANT - CLUTCHING - ADHESIVA - ADESIVO - SAMEN	P.41

43

A NEAU - RING - ANILLO - ANNEL - RING	P.44
B RIDE - FLANGE - BRIDA - FREIO - FLENS	P.46
C ADENAS - PADLOCK - CANDADO - CANDEADO - HANGSLOT	P.46
C OLLIER DE SERAGE - CLAMPING CLIP - ABRAZEDERA - SEGURE COLARINHO - KLEMKRAAG	P.47
C OSSE COEUR - STEEL THIMBLE - GUARDA CABO - DEDAL - BEUGELHUIS	P.47
C ROCHET - HOOK - GANCHO - HAAK	P.48
E LASTIQUE - ELASTIC - ELASTICA - ELASTICO - ELASTIEK	P.50
E SSE - HOOK «S» - GANCHO «S» - HAAK «S»	P.50
G OUPILLE - PIN - PASADOR - LINGUETA	P.52
H UIT DE REGLAGE - STEEL HEIGHT - OCHO - OITO - ACHT	P.55
M AILLON - LINK - ESLABON - LIGAÇÃO - SCHAKEL	P.55
M ANILLE - SHAKEL - GRILLETE - MANILA - BEUGEL	P.58
M OUSQUETON - SNAP HOOK - MOSQUETON - MOSQUETAO - KARABIJNHAAK	P.60
O EILLET - EYELET - OJETES - CRAVO - ANJER	P.64
P INCE RESSORT - SPRING CLIP - PINZA RESSORTE - PINÇA MOLA - TANG VEER	P.64
P IQUET - PEG - PIQUETA - PIQUETE - PIN	P.64
P LATINE À OEIL - PLATE - PLATINA - PLATINHA - LANGE	P.64
P ORTE CLÉS - KEY RING - LLAVERO - CHAVEIRO - STEULHANGER	P.65
P ORTE ÉTIQUETTE - LABEL HOLDER - PORTA ETIQUETAS - SUPPORTE ETIQUETAS - ETIKETHOUDER	P.65
P OULIE - PULLEY - POLEA - TALHA - KATROL	P.65
R AIDISSEUR - WIRE STRAINER - TENSOR PARA ALAMBRE - ESTOCADOR PARA ARAME - KABEL SCHOTJE	P.76
R ESSORT - SPRING - RESORTE - MOLA - VEER	P.69
S ERRE CÂBLE - ROPE CLIP - SUJETA CABLE - SERRA CABO - KABLECLIP	P.70
S ERRE CORDE - ROPE CLIP - SUJETA CUERDA - SERRA CORDA - TOUWCLIP	P.70
T AQUET - CLEAT - TACO - TRAVA - KLAMP	P.73
T ENDEUR - TURNBUCKLE - TENSOR - ESTICADOR - SPANSCHROEF	P.73
T OURET - DRUMB - TAMBOR	P.75

VOLETS ROULANTS - SHUTTERS - PERSIANAS - LUIKEN

77

E NROULEUR - ROLLER BLIND - RECOGEDOR - RETRATOR - OPROLMECHANIESM	P.78
S ANGLE - STRAP - CORREA - CORREIA - SPANRIEM	P.78
A CCESOIRES - ACCESSORIES - ACCESORIOS - ACESSORIOS - TOEBEHOREN	P.79

TUYAUX CRISTAL - HOSE - MANGUERA - MANGUEIRA - SLANG

83

T UYAUX ET ACCESSOIRES - HOSES AND ACCESSORIES - M ANGUERA Y ACCESORIOS - MANGUEIRA E ACESSORIOS S LANG EN TOEBEHOREN	P.84
--	------

PICTOGRAMMES

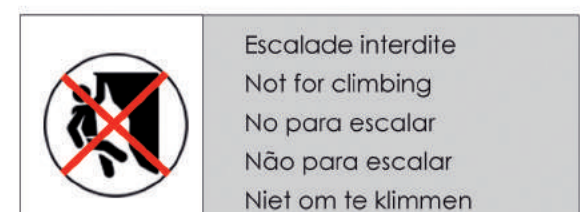
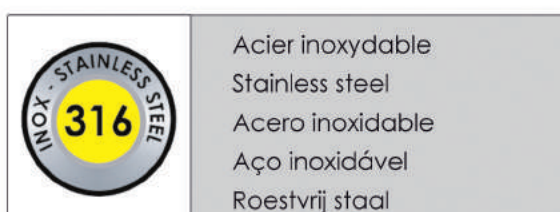
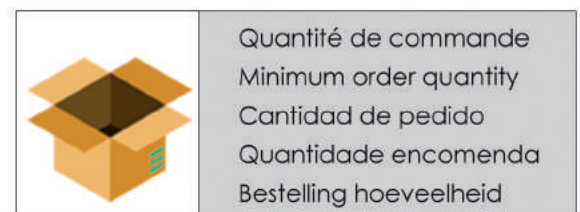
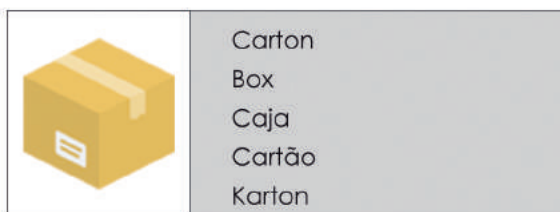
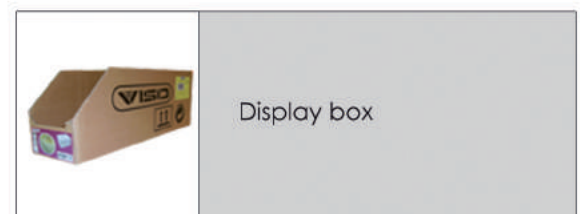
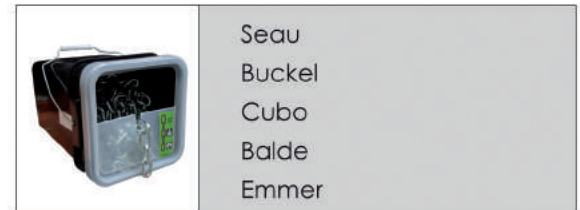
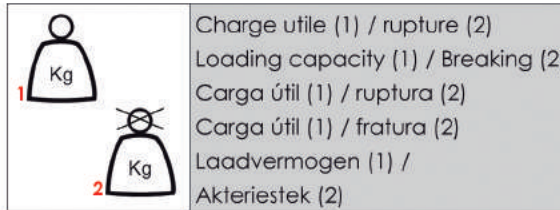
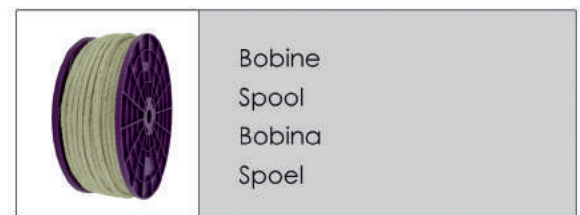
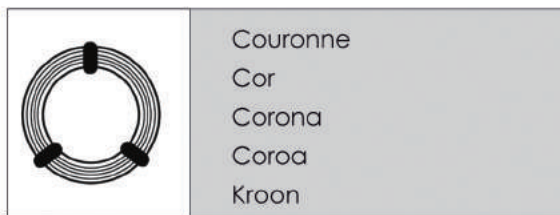
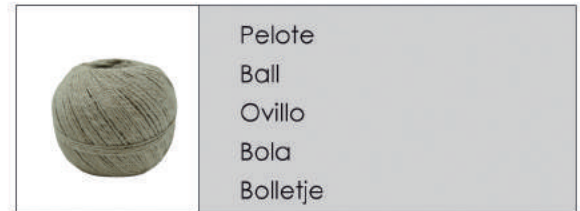
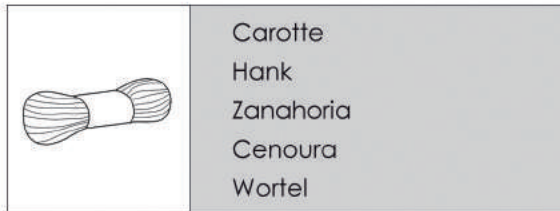
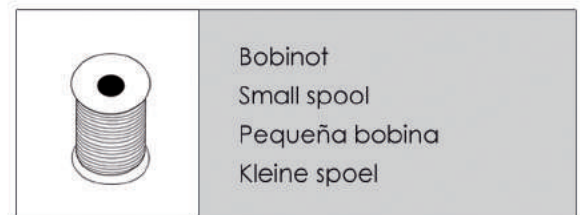
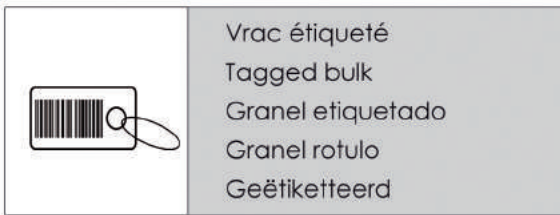
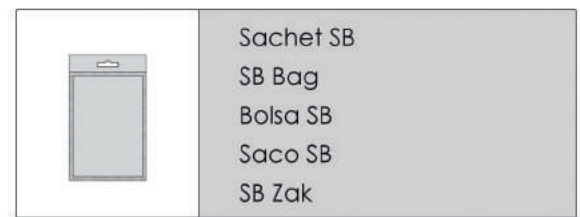
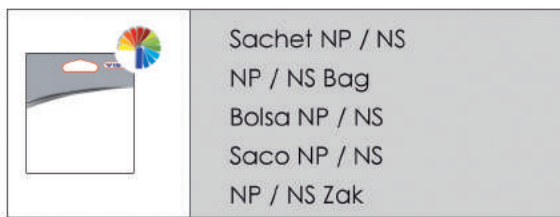



CABLE ACIER TYPE AVIATION ÂME MÉTAL
GALVANIZED STEEL AIRCRAFT CABLE WITH STEEL CORE

CABLE ACERO GALVANIZADO DE AVIACION
CABO DE AÇO GALVANIZADO

STAALKABEL LUCHTVAART

Code	Type	∅ mm	KG				
CAM 151/30	1 x 7	1,5	40	15m	-	-	30
CAM 201	7 x 7	2	47	15m	-	-	24
CAM 411	7 x 19	5	516	15m	-	-	9
CAM 801	7 x 19	8	848	15m	-	-	5
CAM 159 NB/200	1 x 7	1,5	40	-	200m	1	-
CAM 209 NB/200	7 x 7	2	47	-	200m	1	-
CAM 409 NB	7 x 19	4	252	-	100m	1	-
CAM 509 NB	7 x 19	5	358	-	50m	1	-
CAM 609 NB	7 x 19	6	516	-	50m	1	-
CAI 309 NB	7 x 19	3	135	-	100m	1	-
CAI 409 NB	7 x 19	4	252	-	100m	1	-
CAI 609 NB	7 x 19	6	516	-	50m	1	-

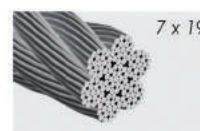
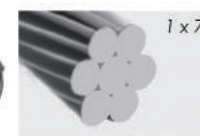

CABLE ACIER TYPE HORLOGERIE ÂME TEXTILE
GALVANIZED STEEL JEWELRY CABLE WITH TEXTILE CORE

CABLE ACERO GALVANIZADO DE RELOJERIA
CABO DE AÇO GALVANIZADO

STAALKABEL UURWERKMAKERIJ

Code	Type	∅ mm	KG				
CAT 201/24	6 x 7	2	30	15m	-	-	24
CAT 301	6 x 7	3	54	15m	-	-	12
CAT 401	6 x 7	4	120	15m	-	-	9
CAT 601	6 x 7	6	187	15m	-	-	5
CAT 209 NB/200	6 x 7	2	30	-	200m	1	-
CAT 309 NB/100	6 x 7	3	54	-	100m	1	-
CAT 409 NB	6 x 7	4	120	-	100m	1	-
CAT 509 NB	6 x 7	5	147	-	50m	1	-
CAT 609 NB	6 x 7	6	187	-	50m	1	-



CABLE ACIER GAINÉ PVC ÂME TEXTILE
PVC COATED WIRE ROPE WITH TEXTILE CORE

CABLE ACERO GALVANIZADO CON FUNDA PVC
CABO DE AÇO GALVANIZADO REVESTIDO PVC

STAALDRAAD VERPAKT PVC

Code	Type	∅ A mm	∅ B mm	KG				
CLG 301	1 x 7	1,3	3	50	15m	-	-	12
CLG 401	1 x 7	2	4	50	15m	-	-	9
CLG 501	1 x 7	2,5	5	70	15m	-	-	5
CLG 306 NB	1 x 7	1,3	3	70	-	100m	1	-
CLG 406 NB	1 x 7	2	4	100	-	100m	1	-
CLG 506 NB	1 x 7	2,5	5	100	-	50m	1	-

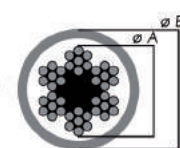



CABLE ACIER GAINÉ PVC
PVC COATED WIRE ROPE

CABLE ACERO GALVANIZADO CON FUNDA PVC
CABO DE AÇO GALVANIZADO REVESTIDO PVC

STAALDRAAD VERPAKT PVC

Code	Type	∅ A mm	∅ B mm	kg				
CTG 301	6 x 7	2	3	54	15m	-	-	12
CTG 401	6 x 7	3	4	150	15m	-	-	9
CTG 501	6 x 7	4	5	220	15m	-	5	-
CTG 309 NB/100	6 x 7	2	3	54	-	100m	1	-
CTG 409 NB	6 x 7	3	4	150	-	100m	1	-
CTG 509 NB	6 x 7	4	5	220	-	50m	1	-



CORDE À LINGE ÂME MÉTAL
CLOTHES LINE STEEL CORE

CUERDA TENDER CADA METAL
CORDA À ROUPA ALMA METAL

WASLIJN STAALEN

Code	∅ mm			
CLT 201	2,7	20m	-	12
CLM 601	2,7	-	60m	6
CLM 431	3,8	-	30m	6



CORDE À LINGE ÂME TEXTILE
CLOTHES LINE TEXTILE CORE

CUERDA TENDER CADA TEXTIL
CORDA À ROUPA ALMA TÊXTEL

WASLIJN TEXTILEN

Code	∅ mm					
CLTP 201	2,4	20m	-	-	-	24
CLT 105 CROS	5	10m	-	-	10	-
CLT 115 CROS	5	15m	-	-	10	-
CLT 255 CROS	5	25m	-	-	10	-
CLT 306 NB	3	-	-	250m	1	-
CLT 406 NB	4	-	-	150m	1	-
FNY 061	0,6	-	100m	-	5	-



FIL À LINGE ACIER PLASTIFIÉ
PVC COATED STEEL WIRE

HILO TENDER ACERO PLASITIFICADO
FIO À ROUPA AÇO DE PLASTICO

WASLIJN GEPLASTICEERDE

Code		∅ mm		
FLB 227		2,7	20m	6
FLV 227		2,7	20m	6







FIL D'ATTACHE ACIER GALVANISÉ
GALVANIZED STEEL WIRE

ATADURA ACERO GALVANIZADO
HILO DE AMARRE AÇO GALVANIZADO

DRAAD STAALEN

Code	∅ mm			
FFG 071	0.7	100m	-	12
FFG 091	0.9	50m	-	12
FFG 111	1.1	50m	-	12
FFG 131	1.3	50m	-	12
FFG 151	1.5	50m	-	12
FFG 221	2.2	50m	6	-



FIL D'ATTACHE ACIER PLASTIFIÉ
PVC COATED STEEL WIRE

ATADURA ACERO PLASTIFICADO
FIO DE AÇO PLASTICO

DRAAD KUNSTSOFF STAAL

Code		∅ mm			
FPB 081		1,3	50m	-	12
FPB 101		1,5	50m	-	12
FPB 151		2	50m	-	12
FPV 081		1,3	50m	-	12
FPV 101		1,5	50m	-	12
FPV 151		2	50m	-	12
FPV 2400		2,4	100m	6	-
FPV 2800		2,8	100m	6	-
LPV 041		3	30	12	-



FIL LAITON
BRASS WIRE

HILO DE LATON
FIO DE BRONZE

DRAAD BRONS

Code	∅ mm		
FIL 091	0,9	30 m	12





FIL CARCASSE
GALVANIZED STEEL WIRE

HILO DE ACERO
FIO DE AÇO

DRAAD STAALEN

Code	Ø mm				
FCG 032 NP	0,3	●	50 m	2	5
FCG 052 NP	0,5	●	20 m	2	5
FCL 042 NP	0,4	●	30 m	2	5
FCC 042 NP	0,4	●	30 m	2	5
FCV 042 NP	0,4	●	30 m	2	5



FCG = Acier galvanisé - Galvanized steel - Acero galvanizado - Aço galvanizado - Gegalvaniseerd staal
 FCL = Laiton - Brass - Latón - Bronze - Brons
 FCV = Acier plastifié - Plasticized steel - Acero plastificado - Aço plastificado - Geplastificeerde staal
 FCC = Cuivre - Copper - Cobre - Kopper

RAIDISSEUR POUR FIL DE TENSION
WIRE STRAINER

TENSOR PARA ALAMBRE
ESTICADOR PARA ARAME

KABEL SCHOTJE

Code					
RCB 97 E	n°2	>2mm	○	1	80
RCV 97 E/80	n°2	>2mm	●	1	80
RCV 115 E	n°3	>2,4mm	●	1	60
RCZ 97 E	n°3	>2mm	●	1	80
RCZ 115 E	n°3	>2,4mm	●	1	60
RCZ 135 E	n°4	>2,75mm	●	1	30



CHAPEAU EN ACIER POUR POTEAU
POST CAP

SOMBRETE DE ACERO
CHAPEU DE AÇO

STAAL HAT

Code	L x l mm	H mm		
CH 7 E	70 x 70	25	1	15
CH 9 E	90 x 90	25	1	15

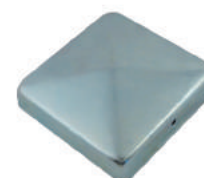



CHAÎNE DROITE SOUDÉE MAILLON LONG ACIER ZINGUÉ
STEEL WELDED CHAIN LONG LINK ZINC PLATED

CADENA RECTA ESLABON LARGO
CADEIA SOLDADO ELO LONGO

LANGCHALMILGE KETTINGEN

Code	ø mm								
DIN 125 NP	2	5m	-	-	-	-	8 x 22 mm	25	5
DIN 155 NP	2.5	5m	-	-	-	-	4 x 24 mm	38	5
DIN 175 NP	3	5m	-	-	-	-	6 x 27 mm	56	5
DIN 185 NP	3.5	5m	-	-	-	-	8 x 21 mm	75	5
DIN 194 NP	4	4m	-	-	-	-	8 x 32 mm	100	5
DIN 213 NP	5	3m	-	-	-	-	9 x 35 mm	160	5
DIN 232 NP	6	2m	-	-	-	-	12 x 42 mm	225	5
DIN 251 NP	7	1m	-	-	-	-	13 x 49 mm	375	5
DIN 235 SB	6	-	5m	-	-	-	12 x 42 mm	225	1
DIN 273 SB	8	-	3m	-	-	-	14 x 51 mm	400	1
DIN 156 NB	2.5	-	-	50m	-	-	4 x 24 mm	38	1
DIN 179 NB	3	-	-	25m	-	-	6 x 27 mm	56	1
DIN 199 NB	4	-	-	25m	-	-	8 x 32 mm	100	1
DIN 236 NB	6	-	-	25m	-	-	12 x 42 mm	225	1
DIN 276 NB	8	-	-	12,5m	-	-	14 x 51 mm	400	1
DIN 124 C	2	-	-	-	4 x 50m	-	8 x 22 mm	25	1
DIN 154 C	2.5	-	-	-	4 x 25m	-	4 x 24 mm	38	1
DIN 174 C	3	-	-	-	3 x 25m	-	6 x 27 mm	56	1
DIN 184 C	3.5	-	-	-	3 x 25m	-	8 x 21 mm	75	1
DIN 194 C	4	-	-	-	25 m	-	8 x 32 mm	100	1
DIN 214 C	5	-	-	-	25 m	-	9 x 35 mm	160	1
DIN 234 C	6	-	-	-	2 x 25m	-	12 x 42 mm	225	1
DIN 254 C	7	-	-	-	25 m	-	13 x 49 mm	375	1
DIN 274 C	8	-	-	-	25 m	-	14 x 51 mm	400	1
DIN 304 C	10	-	-	-	20 m	-	19,5 x 65 mm	775	1
DIN 121 CT	2	-	-	-	-	50m	8 x 22 mm	25	1
DIN 151 CT	2.5	-	-	-	-	25m	4 x 24 mm	38	1
DIN 171 CT	3	-	-	-	-	25m	6 x 27 mm	56	1
DIN 181 CT	3.5	-	-	-	-	25m	8 x 21 mm	75	1
DIN 191 CT	4	-	-	-	-	25m	8 x 32 mm	100	1
DIN 211 CT	5	-	-	-	-	25m	9 x 35 mm	160	1
DIN 231 CT	6	-	-	-	-	25m	12 x 42 mm	225	1
DIN 251 SBS	7	-	-	-	-	25m	13 x 49 mm	375	1
DIN 271 SBS	8	-	-	-	-	25m	14 x 51 mm	400	1
DIN 301 SBS	10	-	-	-	-	20m	19,5 x 65 mm	775	1

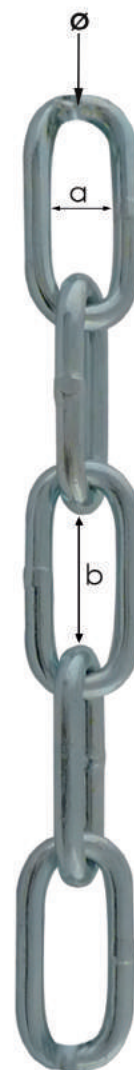

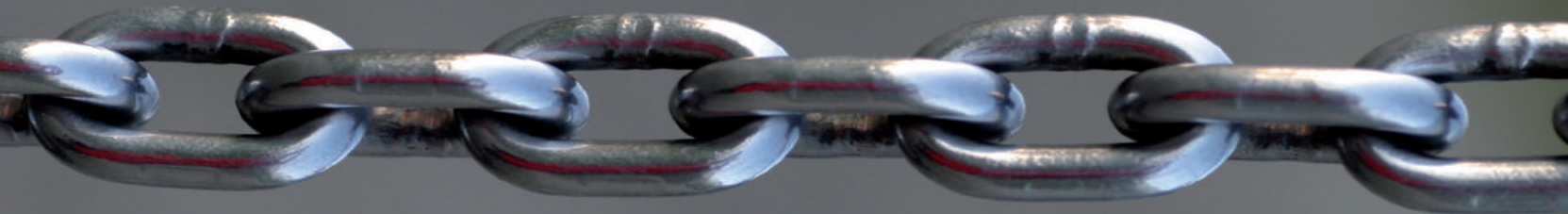

CHAÎNE DROITE SOUDÉE MAILLON COURT ACIER ZINGUÉ
STEEL WELDED CHAIN SHORT LINK ZINC PLATED

CADENA RECTA ESLABON SOLDADO
CADEIA SOLDADO ELO CURTO

KORTSCHALMILGE KETTINGEN GELAST

Code	∅ mm								
GEN 1210 NP	2	10m	-	-	-	-	3 x 14 mm	25	5
GEN 145 NP	2,5	5m	-	-	-	-	5 x 17 mm	25	5
GEN 175 NP	3	5m	-	-	-	-	5 x 16 mm	25	5
GEN 185 NP	3,5	5m	-	-	-	-	6 x 19 mm	25	5
GEN 194 NP	4	4m	-	-	-	-	8 x 20 mm	38	5
GEN 213 NP	5	3m	-	-	-	-	9 x 23 mm	38	5
GEN 232 NP	6	2m	-	-	-	-	10 x 24,5mm	38	5
GEN 261 NP	8	1m	-	-	-	-	14 x 33 mm	56	5
GEN 126 NB	2	-	-	50m	-	-	3 x 14 mm	25	1
GEN 146 NB	2,5	-	-	50m	-	-	5 x 17 mm	25	1
GEN 176 NB	3	-	-	50m	-	-	5 x 16 mm	25	1
GEN 196 NB	4	-	-	25m	-	-	8 x 20 mm	38	1
GEN 216 NB	5	-	-	25m	-	-	9 x 23 mm	38	1
GEN 124 C	2	-	-	-	200 m	-	3 x 14 mm	100	1
GEN 144 C	2,5	-	-	-	75 m	-	3 x 14 mm	100	1
GEN 174 C	3	-	-	-	75 m	-	5 x 16 mm	100	1
GEN 184 C	3,5	-	-	-	50 m	-	6 x 19 mm	100	1
GEN 194 C	4	-	-	-	50m	-	8 x 20 mm	160	1
GEN 214 C	5	-	-	-	25m	-	9 x 23 mm	160	1
GEN 234 C	6	-	-	-	50 m	-	10 x 24,5mm	160	1
GEN 264 C	8	-	-	-	25 m	-	14 x 33 mm	160	1
GEN 284 C	10	-	-	-	20 m	-	38 x 60mm	225	1
GEN 121 CT	2	-	-	-	-	25m	3 x 14 mm	225	1
GEN 141 CT	2,5	-	-	-	-	25m	3 x 14 mm	225	1
GEN 171 CT	3	-	-	-	-	25m	5 x 16 mm	400	1
GEN 181 CT	3,5	-	-	-	-	25m	6 x 19 mm	400	1
GEN 191 CT	4	-	-	-	-	25m	8 x 20 mm	400	1
GEN 211 CT	5	-	-	-	-	25m	9 x 23 mm	1250	1
GEN 231 CT	6	-	-	-	-	25m	10 x 24,5mm	1250	1
GEN 261 SBS	8	-	25m	-	-	-	14 x 33 mm	56	1
GEN 281 SBS	10	-	20m	-	-	-	20 x 40 mm	56	1



CHAÎNE MAILLON COURT ACIER GALVANISÉ
CHAIN SHORT LINK

CADENA ESLABON CORTO
CADEIA ELO CURTO

KORTSCHALMILGE KETTINGEN

Code	∅ mm				
NAU 064 C	6	25m	-	220	1
NAU 084 C	8	25m	-	400	1
NAU 104 C	10	20m	-	650	1
NAU 061 SBS	6	-	25m	220	1
NAU 081 SBS	8	-	25m	400	1
NAU 101 SBS	10	-	20m	650	1

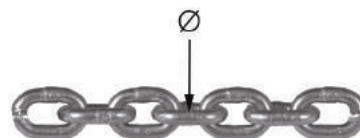

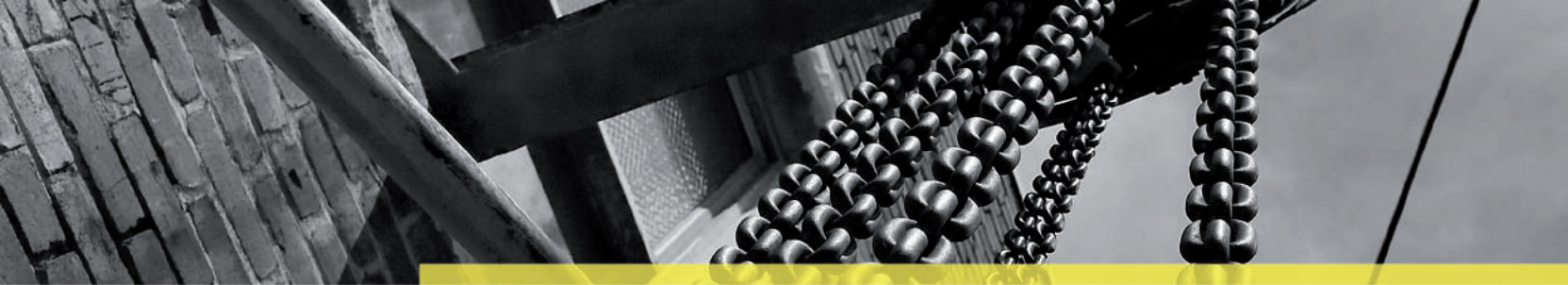

CHAÎNE DROITE SOUDÉE MAILLON LONG
STEEL WELDED CHAIN LONG LINK ZINC PLATED

CADENA RECTA ESLABON LARGO
CADEIA SOLDADO ELO LONGO

LANGCHALMILGE KETTINGEN

Code	∅ mm						
DIN 234 NJC	6		2x15m	-	12 x 42 mm	225	1
DIN 234 RBC	6		2x15m	-	12 x 42 mm	225	1
DIN 233 BL/CT	6		-	15m	12 x 42 mm	225	1
DIN 233 BN/CT	6		-	15m	12 x 42 mm	225	1
DIN 233 NJ/CT	6		-	15m	12 x 42 mm	225	1
DIN 233 R/CT	6		-	15m	12 x 42 mm	225	1
DIN 233 RB/CT	6		-	15m	12 x 42 mm	225	1
DIN 233 V/CT	6		-	15m	12 x 42 mm	225	1



CHAÎNE MAILLON LONG INOX
STAINLESS STEEL CHAIN LONG LINK

CADENA INOXIDABLE ESLABON LARGO
CADEIA INOXIDABLE ELO LONGO

ROESTVRIJE STAAL KETTEN LANG LINK



Code	∅ mm				
CDI 154 C	2,5	2 x 25m	-	38	1
CDI 174 C	3	2 x 25m	-	56	1
CDI 194 C	4	2 x 25m	-	100	1
CDI 214 C	5	25m	-	160	1
CDI 234 C	6	25m	-	225	1
CDI 151 CT	2,5	-	25m	38	1
CDI 171 CT	3	-	25m	56	1
CDI 191 CT	4	-	25m	100	1
CDI 211 CT	5	-	25m	160	1
CDI 231 CT	6	-	25m	225	1



CHAÎNE TORSE SOUDÉE ACIER ZINGUÉ
OVAL TWISTED CHAIN ZINC PLATED

CADENA TRENZADO
CADEIA TORSADA

LOSGEDRAAID KETTEN

Code	∅ mm			
TOR 154 NP	2,5	4m	40	5
TOR 184 NP	3,4	4m	85	5
TOR 203 NP	4,5	3m	160	5
TOR 222 NP	5,5	2m	210	5





CHAÎNE DE PÂTURAGE ACIER NON ZINGUÉ
GRAZING STEEL CHAIN

CADENA DE PASTOREO DE ACERO
CADEIA DE PASTAGEM EM AÇO

STAAL GRASLAND KETTEN



Code	∅ mm		 KG	
CDP 032	3	2m	420	1
CDP 033	3	3m	420	1
CDP 034	3	4m	420	1
CDP 353	3,5	3m	570	1
CDP 354	3,5	4m	570	1
CDP 355	3,5	5m	570	1
CDP 045	4	5m	740	1
CDP 046	4	6m	740	1
CDP 456	4,5	6m	940	1
CDP 457	4,5	7m	940	1
CDP 057	5	7m	1150	1
CDP 556	5,5	6m	1440	1
CDP 558	5,5	8m	1440	1
CDP 069	6	9m	1695	1
CDP 610	6	10m	1695	1
CDP 656	6,5	6m	1950	1



CHAÎNE POUR CHIEN MAILLON LONG ACIER ZINGUÉ
DOG STEELCHAIN

CADENA PERRO ESLABON LARGO
CADEIA CÃO ELO LONGO

HOND STAAL KETTEN



Code	∅ mm		 KG	
LDIN 252 SB	2,5	2m	40	1
LDIN 302 SB	3	1,5m	40	1
LDIN 303 SB	3	3m	40	1
LDIN 403 SB	4	3m	70	1



CHAÎNE SPÉCIALE
SPECIAL CHAIN

CADENA ESPECIAL
CADEIA ESPECIAL

SPECIAAL KETTEN

Code	∅ mm		 KG	
VIC 095 NP	1,4	5m	-	5
CDT 166 NB	1,6	-	50m	5
CDT 165 NP	1,6	5m	-	5
CBC 321 NS	3,2	1m	-	5
CTD 001 NS	19	1m	-	5

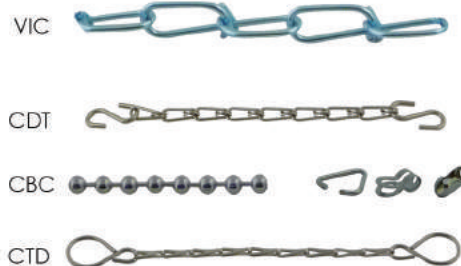



CHAÎNE DÉCORATIVE / DECORATIVE CHAIN CADENA DE DECORACION / CADEIA DE DECORAÇÃO DECORATIEVE KETTEN

Code	∅ mm				
COU 162 NP	1,6		2m	-	5
PMB 222 NP	2,2		2m	9	5
PML 222 NP	2,2		2m	9	5
PMN 222 NP	2,2		2m	9	5
PMN 222 SB	2,2		2m	9	5
TOB 402 NP	4		2m	9	5
TON 402 NP	4		2m	9	5



CHAÎNE DE SIGNALISATION PLASTIQUE / SIGN PLASTIC CHAIN CADENA DE SEÑAL PLASTICO / CADEIA SINĂL DE PLASTICO PLASTIEK KETTEN

Code		∅ mm					
CBR 625 NP		6	-	20 x 35 mm	2,5m	-	5
CBR 820 NP		8	-	25 x 45 mm	2	-	5
CBR 604 C		6	25m	20 x 35 mm	-	-	1
CBR 804 C		8	25m	25 x 45 mm	-	-	1
CBR 601 SBS		6	-	20 x 35 mm	-	25m	1
CBR 801 SBS		8	-	25 x 45 mm	-	25m	1
CMLRB 804 C		8	25m	25 x 65 mm	-	-	1
CMLRB 825 SBS		8	-	25 x 65 mm	-	25m	1
CNJ 604 C		8	25m	25 x 45 mm	-	-	1
CNJ 804 C		6	-	20 x 35 mm	-	25m	1
CNJ 601 SBS		8	-	25 x 45 mm	-	25m	1
CNJ 801 SBS		8	-	25 x 45 mm	-	20m	1
CNJ 101 SBS		10	-	25 x 50 mm	-	25m	1
CBV 804 C		8	25m	25 x 45 mm	-	-	1
CBV 801 SBS		8	-	25 x 45 mm	-	25m	1
CPB 804 C		8	25m	25 x 45 mm	-	-	1
CPB 801 SBS		8	-	25 x 45 mm	-	25m	1
CPN 804 C		8	25m	25 x 45 mm	-	-	1
CPN 801 SBS		8	-	25 x 45 mm	-	25m	1
CPR 801 SBS		8	-	25 x 45 mm	-	25m	1

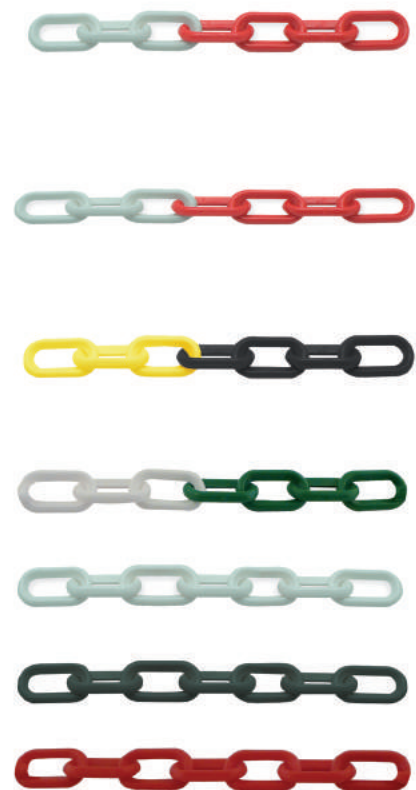



CORDAGE POLYPROPYLÈNE BLANC **CORDAJE POLIPROPILENO BLANCO** **WIT POLYPROPYLEEN TOUW**

WHITE POLYPROPYLENE ROPE CORDA DE POLIPROPILENO BRANCO



Code	Ø mm			
CPP 241	4	20 m	270	8
CPP 161	6	10 m	590	4
CPP 261	6	20 m	590	4
CPP 181	8	10 m	1040	4
CPP 281	8	20 m	1040	5
CPP 101/6	10	10 m	1380	6
CPP 201	10	20 m	1380	3
CPP 121/6	12	10 m	1950	6
CPP 221	12	20 m	1950	4
CPP 5141	14	15 m	2690	2
CPP 7141	14	7,5 m	2690	6
CPP 7161	16	7,5 m	3330	3
CPP 5161	16	15 m	3330	3
CPP 7181	18	7,5 m	4250	2



CORDAGE POLYPROPYLÈNE COULEUR **CORDAJE POLIPROPILENO COLOR** **KER POLYPROPYLEEN TOUW**

COLOR POLYPROPYLENE ROPE CORDA DE POLIPROPILENO COR



Code		Ø mm			
2 CPC 331		3	2 x 30 m	100	6
CPC 2541		4	25 m	140	8
CPB 2561		6	25 m	520	6
CPC 181		8	10 m	960	3
CPM 2581		8	25 m	960	6
CPC 101		10	10 m	1380	3
CPC 1501		10	15 m	1380	6
CPV 1521		12	15 m	1950	6
CPV 151 CROS		5	10 m	420	10
CPV 1551 CROS		5	15 m	420	10
CPV 2251 CROS		5	25 m	420	10
CPP 206 CROS		6	20 m	520	32



CROSS



CORDAGE POLYPROPYLÈNE
POLYPROPYLENE ROPE

CORDAJE POLIPROPILENO
CORDA DE POLIPROPILENO

POLYPROPYLEEN TOUW



Code		Ø mm			
CBL 069 NB	○	6	165m	590	1
CBL 089 NB	○	8	90m	10400	1
CBL 109 NB	○	10	60m	1380	1
CBL 129 NB	○	12	45m	1950	1
CBL 149 NB	○	14	30m	2690	1
CBL 169 NB	○	16	25m	3330	1
CBL 189 NB	○	18	15m	4250	1
<hr/>					
CPP 042 NB	●	4	250m	270	1
CPP 069 NB	●	6	165m	590	1
CPP 082 NB	●	8	100m	1040	1
CPP 109 NB	●	10	60m	1380	1
CPP 122 NB	●	12	50m	1950	1
CPP 149 NB	●	14	30m	2690	1



CORDAGE POLYPROPYLÈNE GRANDE LONGUEUR
POLYPROPYLENE ROPE LONG LENGTH

CORDAJE POLIPROPILENO GRAN LONGITUD
CORDA DE POLIPROPILENO GRANDE COMPRIMENTO

POLYPROPYLEEN TOUW GROTE LENGTE



Code		Ø mm			
CBL 167 NB	○	16	75m	3330	1
CBL 187 NB	○	18	60m	4250	1
CBL 207 NB	○	20	50m	5120	1
<hr/>					
CPP 087 NB	●	8	265m	1040	1
CPP 107 NB	●	10	200m	1380	1
CPP 127 NB	●	12	135m	1950	1
CPP 147 NB	●	14	100m	2690	1



Pour / For
PB3

CORDAGE POLYPROPYLÈNE
POLYPROPYLENE ROPE

CORDAJE POLIPROPILENO
CORDA DE POLIPROPILENO

POLYPROPYLEEN TOUW



Code	Ø mm			
CBL 065	6	100m	590	1
CBL 085	8	100m	1040	1
CBL 105	10	100m	1380	1
CBL 125	12	100m	1950	1
CBL 145	14	100m	2690	1
CBL 165	16	100m	3330	1
CBL 185	18	100m	4250	1
CBL 205	20	100m	5120	1





CORDAGE MIXTE SISAL / POLYPROPYLÈNE
SISAL / POLYPROPYLENE ROPE

CORDAJE SISAL / POLIPROPILENO
CORDA DE SISAL / POLIPROPILENO

SISAL / POLYPROPYLEEN TOUW



Code	∅ mm					
COR 061	6	10m	-	235	8	-
COR 062 NB	6	-	165m	235	-	1
COR 082 NB	8	-	80m	480	-	1
COR 102 NB	10	-	60m	585	-	1
COR 122 NB	12	-	40m	880	-	1
COR 142 NB	14	-	30m	1200	-	1



CORDAGE CHANVRE
HEMP ROPE

CORDAJE CÁÑAMO
CORDA DE CÂNHAMO

HENNEP TOUW

Code	∅ mm						
COC 281	8	20m	-	-	350	5	-
COC 201	10	20m	-	-	570	3	-
COC 221	12	20m	-	-	795	2	-
COC 5141	14	15m	-	-	1090	2	-
COC 1181	18	10m	-	-	1690	2	-
CCH 109 NB	10	-	60m	-	570	-	1
CCH 122 NB	12	-	40m	-	795	-	1
CCH 149 NB	14	-	35m	-	1090	-	1
CCH 189 NB	18	-	15m	-	1690	-	1



CORDAGE CHANVRE
HEMP ROPE

CORDAJE CÁÑAMO
CORDA DE CÂNHAMO

HENNEP TOUW

Code	∅ mm			
CCP 301 SB	20	30m	1620	1



CHABLOT
ROPE

CORDAJE
CORDA

TOUW

Code	∅ mm			
CHPP 1*	11	4m	-	5
CHCH 121**	11	4m	-	5
CTR 111	11	10m	800	4



* Polypropylène / Polypropylene / Polipropileno / Polypropyleen (sur commande / special order)

** Chanvre / Hemp / Cáñamo / Canamho / Hennepe (sur commande / special order)



DRISSE POLYPROPYLÈNE BLANC / **WHITE POLYPROPYLENE HALYARD** / **DRIZA POLIPROPILENO BLANCO** / **CABO DE POLIPROPILENO BRANCO** / **WIT POLYPROPYLEEN VAL**



Code	Ø mm				
DSA 221	2	-	35 m	50	12
DSA 131	3	-	15 m	75	14
DSA 231	3	-	35 m	75	8
DSA 141	4	-	12 m	170	10
DSA 241	4	-	27 m	170	8
DSA 151	5	-	10 m	240	12
DSA 251	5	-	20 m	240	7
DSA 351	5	-	30 m	240	6
DSA 15/200	1,5	-	200 m	40	4
DSA 2/100	2	-	100 m	50	5
DSA 25/100	2,5	-	100 m	80	4
DSA 3/100	3	-	100 m	90	4
DSA 4/100	4	-	100 m	170	5
DSA 5/100	5	-	100 m	240	4
DSA 6/100	6	-	100 m	300	3
DRA 161	6	10m	-	300	7
DRA 261	6	20m	-	300	9
DRA 361	6	30m	-	300	7
DRA 181	8	10m	-	600	6
DRA 281	8	20m	-	600	7
DRA 101	10	10m	-	900	6
DRA 201	10	20m	-	900	4
DRA 121	12	10m	-	1200	6
DRA 221	12	20m	-	1200	6
DRA 1141	14	10m	-	1500	4



DRISSE POLYPROPYLÈNE COULEUR / **COLOR POLYPROPYLENE HALYARD** / **DRIZA POLIPROPILENO COLOR** / **COR CABO DE POLIPROPILENO** / **KER POLYPROPYLEEN VAL**



Code		Ø mm			
DSC 231		3	35m	75	8
DSV 221		2	35m	50	12
DSV 231		3	35m	75	8
DSV 141		4	12m	150	10



DRISSE POLYPROPYLÈNE / **POLYPROPYLENE HALYARD** / **DRIZA POLIPROPILENO** / **CABO DE POLIPROPILENO** / **POLYPROPYLEEN VAL**



Code		Ø mm			
DSJ 420 CROS		4	20m	150	10
DSP 420 CROS		4	20m	150	10
DSV 420 CROS		4	20m	150	10
DSVB 405 CROS		4	5m	150	10
DSVB 410 CROS		4	10m	150	10
DSVB 415 CROS		4	15m	150	10
DSVB 425 CROS		4	25m	150	10





DRISSE POLYPROPYLÈNE
POLYPROPYLENE HALYARD

DRIZA POLIPROPILENO
CABO DE POLIPROPILENO

POLYPROPYLEEN VAL



Code		∅ mm			
DSA 022 NB	○	2	200m	50	1
DSA 282 NB	○	3	200m	75	1
DSA 042 NB	○	4	200m	170	1
DSA 059 NB	○	5	115m	240	1
DRA 069 NB	○	6	85m	300	1
DRA 089 NB	○	8	40m	600	1
DRA 109 NB	○	10	30m	900	1
DSC 282 NB	●	3	200m	75	1
DSV 282 NB	●	3	200m	75	1
DRV 042 NB	●	4	200m	170	1
DRN 042 NB	●	4	200m	170	1

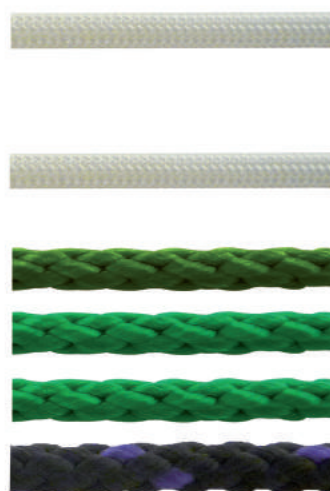

DRISSE POLYPROPYLÈNE
POLYPROPYLENE HALYARD

DRIZA POLIPROPILENO
CABO DE POLIPROPILENO

POLYPROPYLEEN VAL



Code	∅ mm			
DRA 085	8	100m	600	1
DRA 105	10	100m	900	1
DRA 125	12	100m	1200	1



DRISSE POLYPROPYLÈNE
POLYPROPYLENE HALYARD

DRIZA POLIPROPILENO
CABO DE POLIPROPILENO

POLYPROPYLEEN VAL



Code	∅ mm			
EPPE 089 NB	8	40m	500	1



























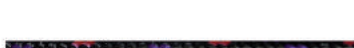





























DRISSE POLYESTER
POLYESTER HALYARD

DRIZA POLIÉSTER
CABO POLIÉSTER

POLYESTER VAL











Code		Ø mm						
DBV 251		5	20 m	-	240	7	-	
DBV 281		8	20 m	-	600	7	-	
DLB 261		6	20 m	-	300	9	-	
DNL 141		4	12 m	-	150	10	-	
DNL 161		6	10 m	-	300	7	-	
DNL 101		10	10 m	-	750	6	-	
DPF 231		3	35 m	-	75	8	-	
DPF 251		5	20 m	-	240	7	-	
DRF 241		4	27 m	-	150	7	-	
DRF 261		6	20 m	-	300	9	-	
DRF 281		8	20 m	-	500	7	-	
DSB 231		3	35 m	-	75	8	-	
DSB 251		5	20 m	-	240	7	-	
DBB 241		4	27 m	-	150	7	-	
DBB 261		6	20 m	-	300	9	-	
DSJ 231		3	35 m	-	75	8	-	
DSJ 141		4	12 m	-	150	10	-	
DSJ 261		6	20 m	-	300	9	-	
DSN 231		3	35 m	-	75	8	-	
DSR 141		4	12 m	-	150	10	-	
DVF 241		4	27 m	-	150	7	-	
DPPE 201		10	10 m	-	590	4	-	
DPPE 069 NB		6	-	85m	700	-	1	

DRISSE POLYAMIDE
POLYAMIDE HALYARD

DRIZA POLIAMIDA
CABO POLIAMIDA

POLYAMIDE VAL



Code		Ø mm				
DPB 031		3	15m	75	12	
DPB 041		4	12m	150	10	



FICELLE POLYPROPYLÈNE
POLIPROPILENE TWINE

CORDEL POLIPROPILENO
FIO POLIPROPILENO

POLYPROPYLEEN TOUWTJE



Code		Ø mm				
3 FPP 41		1,6	≈ 40m (x3)	-	-	4
FPP 101		1,6	≈ 90m	≈ 100g	-	10
FPP 161		3	≈ 88m	≈ 250g	-	8
FPP 221		5,5	≈ 640m	≈ 2Kg	1	-



FICELLE JUTE
JUTE TWINE

CORDEL YUTE
FIO JUTA

JUTE TOUWTJE

Code	Ø mm				
FJF 101	2	≈ 38m	≈ 100g	-	12
FJF 121	2	≈ 94m	≈ 250g	-	8
FJF 151	2,5	≈ 200m	≈ 550g	-	3
FJM 101	3	≈ 18m	≈ 100g	-	12
FJM 121	3	≈ 47m	≈ 250g	-	8
FJM 211	3	≈ 188m	≈ 1Kg	-	6
FJM 221	3	≈ 470m	≈ 2,5Kg	1	-
FJG 221	4	≈ 250m	≈ 2,5Kg	1	-



FICELLE SISAL
SISAL TWINE

CORDEL SISAL
FIO SISAL

SISAL TOUWTJE

Code	Ø mm				
3 FSF 51	2	≈ 18m (x3)	≈ 50 g	-	8
FSF 101	2	≈ 38m	≈ 100 g	-	12
FSF 121	2	≈ 94m	≈ 250 g	-	8
FSF 151	2,5	≈ 200m	≈ 650 g	-	3
FSM 101	3	≈ 18m	≈ 100 g	-	12
FSM 121	3	≈ 47m	≈ 250 g	-	8
FSM 151	3	≈ 94m	≈ 500 g	-	6
FSM 211	3	≈ 188m	≈ 1 Kg	-	6
FSM 221	3	≈ 470m	≈ 2,5 Kg	1	-
FSG 221	4	≈ 250m	≈ 2,5 Kg	1	-
FILAS 1 *	-	-	≈ 1 Kg	1	-





* Sur commande / special order



FICELLE LIN
LINEN TWINE

CORDEL LINO
FIO LINO

VLAS TOUWTJE

Code	∅ mm		
FCC 111	≈ 1 / 1,5	≈ 90m	200
FCC 151	≈ 1,5 / 1,8	≈ 100m	10



FICELLE LIN
LINEN TWINE

CORDEL LINO
FIO LINO

VLAS TOUWTJE

Code	∅ mm		
FCB 101	≈ 1	≈ 164 m	12
FCE 101	≈ 1	≈ 90 m	10



FCB 101



FCE 101

FICELLE RAYONNE
TWINE

CORDEL RAYON
FIO DE RAYON

TOUWTJE



Code	∅ mm		
FRA 051	≈ 1	≈ 100 m	30



CORDEAU DE MAÇON COTON CÂBLÉ
MASON LINE COTTON CABLED

TENDEL DE ALBAÑIL ALGODON CABLE
CAMA MASON ALGODÃO FIO

KRIJT BEKABELD KATOEN

Code	∅ mm		
CMC 151	1,5	60m	10
CMC 201	2	45m	10
CMC 251	2,5	30m	10
CMC 301	3	20m	10







CORDEAU DE MAÇON COTON TRESSÉ
MASON LINE COTTON BRAIDED

TENDEL DE ALBAÑIL ALGODON TRENZADO
CAMA MASON ALGODÃO TRANÇADO

KRIJT GEVLOCHTEN KATOEN

Code	∅ mm		
CMT 151 *	1,5	59 m	10
CMT 1525	1,5	145 m	8
CMT 201 *	2	46 m	10
CMT 251 *	2,5	34 m	10
CMT 2525	2,5	85 m	8



* Sur commande / Special order

TRESSE EN NYLON
ROPE NYLON

TRENZA NILON
TRENÇA NAILON

GEVLOCHTEN NYLON TOUW

Code		∅ mm		
RNT 501		1	70m	14
RNT 501 J		1	70m	14
RNT 501 R		1	70m	14
RNT 1015		1,5	50m	14
RNT 1015 J		1,5	50m	14
RNT 1015 R		1,5	50m	14
RNT 1002		2	35m	14
RNT 1002 J		2	35m	14
RNT 1002 R		2	35m	14





SANDOW MONTÉ
BUNGEE CORD

EXTENSOR
TENSOR

BUNGEE KOORD

ECO

Code		Ø mm	L m	*	
B 10 SMO *		6/8	0,6/1m	10*	6
SMO 062 SB/20		6	0,6m	2	20
SMO 082 SB		8	0,8m	2	10
SMO 102 SB		8	1m	2	8



* B 10 SMO = 4 x 1 M - Ø 8 mm & 6 x 0,6 M - Ø 6 mm

SANDOW MONTÉ
BUNGEE CORD

EXTENSOR
TENSOR

BUNGEE KOORD

PREMIUM

Code		Ø mm	L m		
SL 255 NP *		4	0,25m	5	5
SL 62 NP		8	0,6m	2	5
SL 82 NP		10	0,8m	2	5
SL 102 NP		10	1m	2	5
SL 122 NP		12	1,2m	2	5
SLF 62 NP		112 mm	0,6m	2	5
SLF 82 NP		115 mm	0,8m	2	5
AMO 061 NP		8	0,4m	1	5
CAN 254 NP		4	0,2m	2	5
CAN 354 NP		4	0,3m	2	5



FILET EXTENSIBLE
EXPENDABLE NETTING

RED EXTENSIBLE
REDE ESTENDIVEL

REKBAAR NET

Code	Ø mm	L1 mm	L2 mm	
FEX 200 NSB	5	90—150	115—190	6





**SANDOW
BUNGEE CORD**

**EXTENSOR
TENSOR**

BUNGEE KOORD



Code		Ø mm	L m		
SL 420 SB	●	4	20 m	1	9
SL 620 SB	●	6	20 m	1	6
SL 820 SB	●	8	20 m	1	4
SL 120 SB	●	10	20 m	1	4
SGB 820 SB	○	8	20 m	1	4



**SANDOW
BUNGEE CORD**

**EXTENSOR
TENSOR**

BUNGEE KOORD

Code		Ø mm		
SL 402 NB/120	●	4	120 m	1
SL 602 NB/65	●	6	65 m	1
SL 802 NB/35	●	8	35 m	1
SL 102 NB/25	●	10	25 m	1
SLF 122 NB/35	●	12	35 m	1
SGB 802 NB/35	○	8	35 m	1



**SANDOW GRANDE LONGUEUR
BUNGEE CORD BIG LENGHT**

**EXTENSOR GRAND LONGITUD
TENSOR GRANDE DURACAO**

BUNGEE KOORD GROTE

**Pour / For
PB3**

Code		Ø mm		
SL 607 NB	●	6	450m	1
SL 807 NB	●	8	250m	1
SL 107 NB	●	10	180m	1
SGB 807 NB	○	8	250m	1



**SANGLE BOUCLE
BUCKLE RATCHET TIE DOWN**

**CORREA CON HEBILLA
CORREIA COM FIVELA**

RIEM MET GESP

ECO

Code		L m	l mm			
SBP 252 SB *	●	2,5m	25 mm	2	40	20
SMA 252 SB/15 **	○	2,5m	25 mm	2	200	15
SMA 501 SB **	○	5m	25 mm	1	200	20



* Plastique / Plastic / Plástico

** Zamak



SANGLE À CLIQUET
RATCHET TIE DOWN

CORREA CON TRINQUETE
CORREIA COM LINGUETA

SPANRIEM

ECO

Code		L m	l mm		 KG	
SMC 501 SB		5 m	25 mm	1	500	12
SMC 631 SB		6 m	35 mm	1	1200	5
STC 501 SB/12		5 m	25 mm	1	500	12
STC 631 SB		6 m	35 mm	1	1200	5



SANGLE BOUCLE
BUCKLE RATCHET TIE DOWN

CORREA CON HEBILLA
CORREIA COM FIVELA

RIEM MET GESP

PREMIUM

Code		L m	l mm		 KG	
SBE 182 NP		1.8 m	25mm	2	500	1
SME 25 NP		2.5 m	25mm	2	500	1
SME 50 NP		5 m	25mm	1	500	1











SANGLE À CLIQUET POIDS LOURDS
RATCHET TIE DOWN

CORREA CON TRINQUETE
CORREIA COM LINGUETA

SPANRIEM

Code		l m	l mm			
SPL 801		7,5 + 0,5 m	50 mm	1	2000	5
SPL 900		8,5 + 0,5 m	50 mm	1	5000	3



SANGLE À CLIQUET
RATCHET TIE DOWN

CORREA CON TRINQUETE
CORREIA COM LINGUETA

SPANRIEM

PREMIUM

Code		l m	l mm			
SMC 502 NP		5 m	25mm	2	500	1
STC 502 NP		5 m	25mm	2	500	1
SAE 502 NP		5 m	25mm	2	800	1









SANGLE À CLIQUET ALUMINIUM
RATCHET TIE DOWN

CORREA CON TRINQUETE
CORREIA COM LINGUETA

SPANRIEM

PREMIUM

Code		l m	l mm			
SCE 50 NP		5 m	25mm	1	800	1
STE 50 NP		5 m	25mm	1	800	1





SANGLE À CLIQUET FINITION CARBONE
RATCHET TIE DOWN

CORREA CON TRINQUETE
CORREIA COM LINGUETA

SPANRIEM

PREMIUM

Code		l m	l mm		 KG	
SBE 50 NP		5 m	25 mm	1	700	1
SDE 50 NP		5 m	25 mm	1	700	1
SPE 60 NP		6 m	25 mm	1	1500	1



SANGLE BOUCLE RETRACTABLE
RETRACTABLE RATCHET TIE DOWN

CORREA RETRACTABLE
CORREIA REVOCAVEL

INTREKBAR RIEM

PREMIUM

Code		l m	l mm		 KG	
SRE 18 NP		1,8 m	25 mm	1	600	1
SRE 30 NP		3 m	25 mm	1	600	1
SRE 350 NP		3 m	50 mm	1	1500	1



SANGLE BOUCLE AUTOMATIQUE
SMART BUCKLE RATCHET TIE DOWN

CORREA CON HEBILLA INTELIGENTE
CORREIA COM FIVELA INTELIGENTE

RIEM MET SLIMMEGESP

PREMIUM

Code	l m	l mm		 KG	
STE 182 NP	1,8 m	25 mm	2	500	1
STE 302 NP	3 m	25 mm	2	500	1



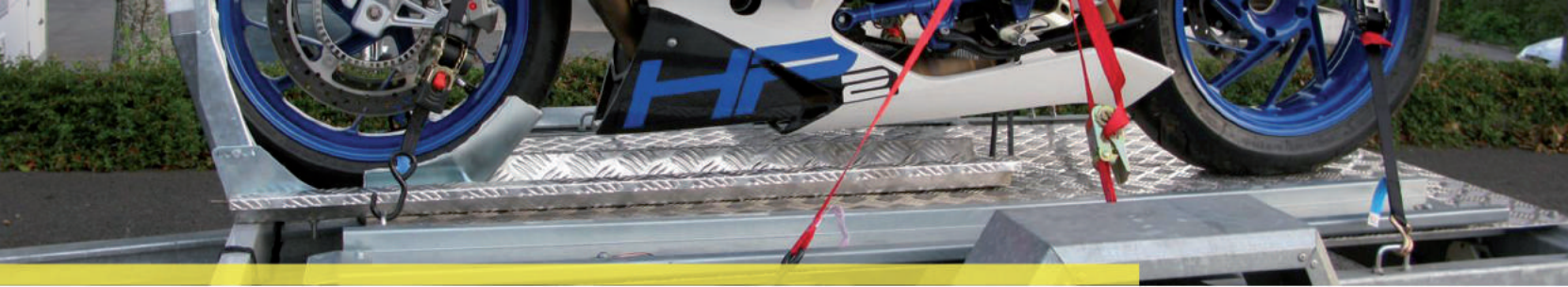

SANGLE À CLIQUET CROCHETS DOUBLE
RATCHET TIE DOWN

CORREA CON TRINQUETE
CORREIA COM LINGUETA

SPANRIEM

PREMIUM

Code	L m	mm			
SPL 20 NP	6 m	35 mm	1	2000	1
SPL 30 NP	6 m	35 mm	1	3000	1
SPL 40 NP	9 m	50 mm	1	4000	1



SANGLE DE TRANSPORT
TRANSPORT RATCHET TIE DOWN

CORREA TRANSPORTE
CORREIA TRANSPORTE

VERVOER RIEM

PREMIUM

Code	L m				
SDT 1 NP	3 m	1	1	80	1
SDT 2 NP	2.5 m / 5 m	2	1	80	1

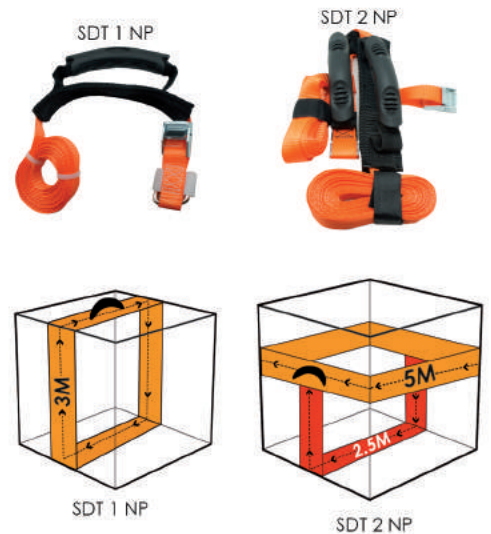

ÉLINGUE
SLING

ESLINGA
LINGA

STROP



	Code			L (m)	
	EP 220		2000	2 m	6
	EP 420		2000	4 m	3
	ER 210		1000	2 m	4
	ER 320		2000	3 m	6
	ER 330		3000	3 m	3
	ER 420		2000	4 m	3



EP 220 / 420



ER 210



SANGLE RATCHET TIE **CORREA CORREIA** **RIEM**

(1) ÉLASTIQUE / ELASTIC / ELASTICA / ELASTICH

(2) JUTE / YUTE / JUTA

(3) POLYPROPYLÈNE / POLYPROPYLENE / POLIPROPILENO / POLYPROPYLEEN

Code	l mm					
SE 604 ⁽¹⁾	60	4m	-	-	-	6
SJK 853 ⁽²⁾ SJK 856 NB ⁽²⁾	90 85	3m -	- 20m	- -	- 1	1 -
SPJ 256 ⁽³⁾ SPJ 259 NB ⁽³⁾ SPN 356 ⁽³⁾ SPN 404 ⁽³⁾	25 25 30 40	6m - 6m 4m	- 25m - -	500 500 1500 2000	- 1 - 16	20 - 20 -

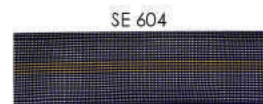

AGRIPPANT CLUTCHING **ADHESIVA ADESIVO** **SAMEN**

Code		l mm	L		
OWR 201 NP		20	1 m	1	5
OWS 630 NP		25	300 mm	6	5
PAS 1912 NP PAS 474 NP	 	∅ 19 ∅ 47	- -	12 4	5 5
STP 235 NP STP 270 NP	 	25 38	350 mm 700 mm	2 1	5 5
VAB 520 NP VAB 550 NP VAN 520 NP VAN 550 NP	 	20 50 20 50	500 mm 500 mm 500 mm 500 mm	1 1 1 1	5 5 5 5

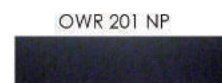



ANNEAU BRISÉ / BROKEN KEY RING **ANILLO ROTO / ANEL QUEBRADO** **GEBROKEN RING**

Code	ØA mm	ØB mm			
ABR 806 NS	19	1,4	6	-	5
ABR 266 NS	23	1,6	6	-	5
ABR 206 NS	26	1,9	6	-	5
ABR 104 NS	30	1,8	4	-	5
ABR 2610 SB	23	1,6	-	10	5



ANNEAU D'ANCRAGE / ANCHOR RING **ANILLO DE ANCLAJE / ANCHO ANEL** **ANKERRING**

Code	ØA mm	ØB mm		
APE 602 NP	35	6	2	5

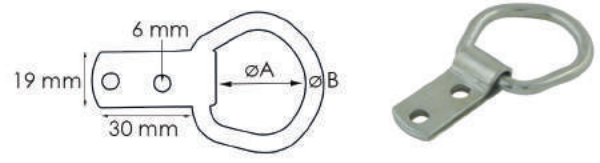

Code	ØA mm	ØB mm	L mm		
AFV 12 E	25	10	120	1	5

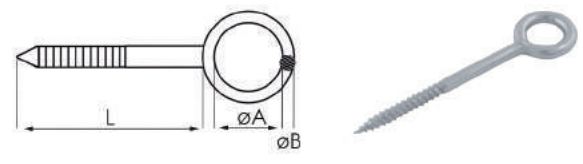

BOULON À OEIL / EYE BOLT **PERNO DE OJO / BOLO DE OLHO** **OOGBOUT**

Code	Ø mm	L mm	KG		
BEI 632 NP	6	60	70	2	5
BEI 761 NP	8	80	140	1	5



ANNEAU D'ÉCURIE À ÉCROU / STABLE RING WITH NUT **ANILLO DE ESTABLE CON TUERCA / ANEL DE ESTABLE COM TUERCA** **STABIELE RING MET MOER**

Code	ØA mm	ØB mm	L mm	KG		
AEE 06 E	50	10	60	200	1	5
AEE 10 E	50	10	100	200	1	5
AEE 121 NE	50	10	120	200	1	5

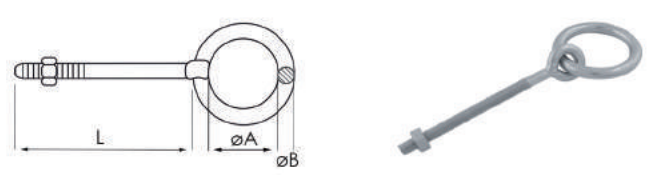

ANNEAU D'ÉCURIE À SCELLER / STABLE RING TO SEAL **ANILLO DE ESTABLE A SELLAR / ANEL DE ESTABLE DE SELO** **DE STALEN RING AFDICHTEN**

Code	ØA mm	ØB mm	L mm	KG		
AES 35 E	50	10	3	200	1	5
AES 07 E	50	10	70	200	1	5
AES 11 E	50	10	110	200	1	5

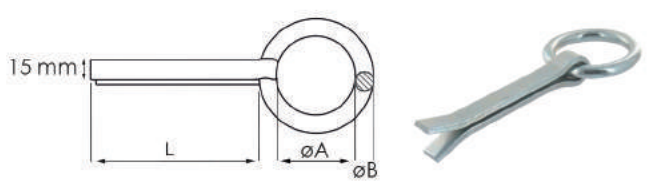



ANNEAU D'ÉCURIE À VISSER
REINFORCING RING

ANILLO DE REFUERZO
ANEL DE REFORÇO

WAPENING VERSTERKEN

Code	ØA mm	ØB mm	L mm	kg		
AEV 55 E	50	10	55	200	1	5
AEV 08 E	50	10	80	200	1	5

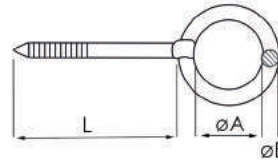

ANNEAU À PLATINE
RING WITH PLATINUM

ANILLO CON PLATINO
ANEL COM PLATINO

RING MET PLATINUM

Code	ØA mm	ØB mm	kg		
APV 80 E	50	8	200	1	5

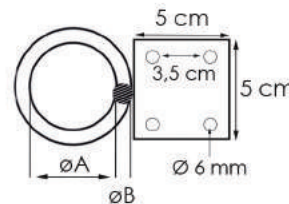

ANNEAU DE LEVAGE
LIFTING RING

ANILLO DE ELEVACIÓN
ANEL DE LEVANTAMENTO

HIJSRING

Code	ØA mm	ØB mm	kg			
ALF 8 E	8	20	140	1	-	5
ALF 10 E	10	25	230	1	-	5
ALF 12 E	12	30	340	1	-	5
ALF 14 E	14	35	500	1	-	5
ALF 825 SBS	8	20	140	-	25	1
ALF 1025 SBS	10	25	230	-	25	1
ALF 1225 SBS	12	30	340	-	25	1
ALF 1425 SBS	14	35	500	-	25	1

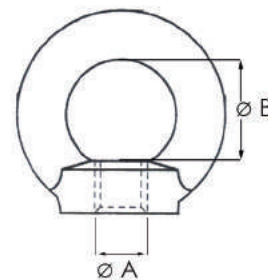

Code	ØA mm	ØB mm	L mm	kg		
ALM 8 E	8	20	13	140	1	5
ALM 10 E	10	25	17	230	1	5
ALM 12 E	12	30	20	340	1	5
ALM 14 E	14	35	20	500	1	5
ALM 825 SBS	8	20	13	140	-	25
ALM 1025 SBS	10	25	17	230	-	25
ALM 1225 SBS	12	30	20	340	-	25
ALM 1425 SBS	14	35	20	500	-	25

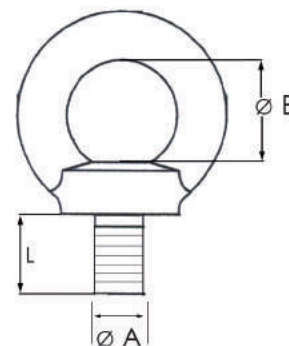

ANNEAU SOUDÉ
WELDED RING

ANILLO SOLDADO
ANEL SOLDADO

RING GELASTE

Code	ØA mm	ØB mm		
ANA 306 NS	22	3	6	5
ANA 403 NS	32	4	3	5
ANA 502 NP	40	5	2	5

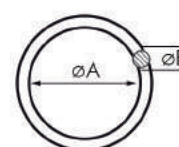



**BRIDE
FLANGE**

**BRIDA
FREIO**

FLENS

Code	ØA mm	B mm	C mm		
BFC 302 NP	5	30	50 → 20	2	5
BFC 402 NP	7	40	60 → 25	2	5
BFT 252 NP	8	32	44 → 15	2	5
BFT 322 NP	8	42	50 → 20	2	5
BFT 382 NP	8	48	52 → 30	2	5

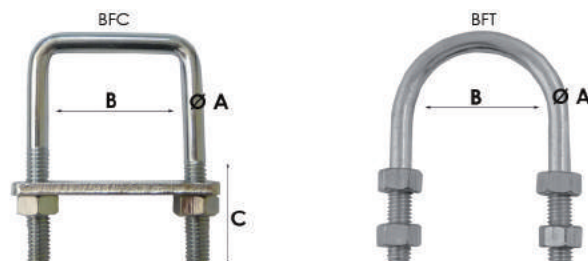

Code	Ø mm		
DMC 106 NS	10	6	5
DMC 122 NS	12	2	5
DMC 222 NP	22	2	5



Code	Ø mm	L mm		
KDN 061 NP	6	60	1	5
KDN 081 NP	8	65	1	5
KDN 101 NP	10	90	1	5

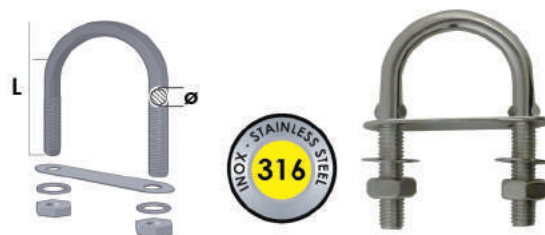

**CADENAS
PADLOCK**

**CANDADO
CANDEADO**

HANGSLLOT

Code	Ø mm	L1 mm	L2 mm			
CAD 203 NP	2,5	11	20	3	-	5
CAD 301 NP	4	16	30	1	-	5
CAD 401 NP	5	23	40	1	-	5
CAD 501 NP	6	30	50	1	-	5
CAD 203 SB	1,5	11	20	-	3	10
CAD 301 SB	4	16	30	-	1	10
CAD 401 SB	5	23	40	-	1	10
CAD 501 SB	6	30	50	-	1	10
CAD 701 GSB	10	42,5	75	-	1	10
CBAG SB	3,5	10	22	-	3	10
CL4 COM SB	5	12	28	-	5	10

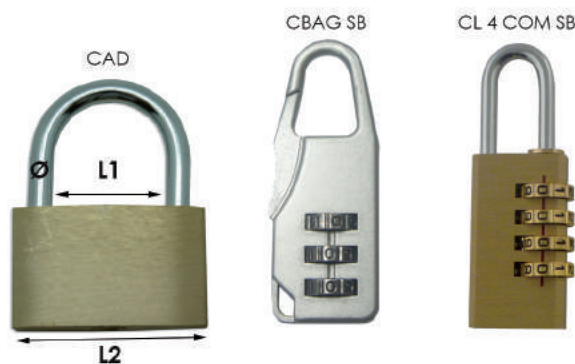





COLLIER DE SERRAGE
CLAMPING CLIP

ABRAZADERA
SEGURE COLARINHO

KLEMKRAAG



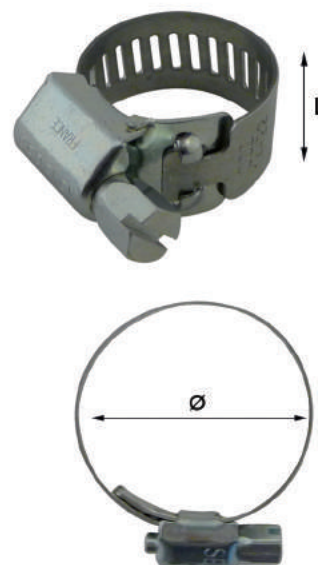

Code	∅ mm	L mm			
CSO 102 NS	10 → 16	8	2	-	5
CSO 182 NS	16 → 28	8	2	-	5
CSO 850 SBS	8 → 12	8	-	50	1
CSO 1050 SBS	10 → 16	8	-	50	1
CSO 1450 SBS	14 → 24	8	-	50	1
CSO 1850 SBS	18 → 28	8	-	50	1
CSO 2425 SBS	24 → 36	8	-	25	1
CS 1425 SBS	14 → 22	14	-	25	1
CS 1825 SBS	18 → 28	14	-	25	1
CS 2425 SBS	24 → 36	14	-	25	1
CS 3225 SBS	32 → 52	14	-	25	1
CS 4025 SBS	40 → 60	14	-	25	1
CS 4725 SBS	47 → 67	14	-	25	1
CS 6225 SBS	62 → 82	14	-	25	1
CS 7725 SBS	77 → 97	14	-	25	1
CS 9225 SBS	92 → 112	14	-	25	1



COSSE COEUR ACIER
STEEL THIMBLE

GUARDA CABO ACERO
AÇO DEDAL

STALEN BEUGELHULS

Code	∅ mm					
COE 204 NS	2/3	4	-	-	-	5
COE 404 NS	4	4	-	-	-	5
COE 604 NS	6	4	-	-	-	5
COE 802 NS	8	2	-	-	-	5
COE 102 NS	10	2	-	-	-	5
COE 122 NP	12	2	-	-	-	5
COE 141 NP	14	1	-	-	-	5
COE 8 E	8	-	-	1	-	5
COE 10 E	10	-	-	1	-	5
COE 12 E	12	-	-	1	-	5
COE 14 E	14	-	-	1	-	5
COE 16 E	16	-	-	1	-	5
COE 204 SB	2/3	-	4	-	-	10
COE 404 SB	4	-	4	-	-	10
COE 2100 SBS	2/3	-	-	-	100	1
COE 4100 SBS	4	-	-	-	100	1
COE 6100 SBS	6	-	-	-	100	1
COE 8100 SBS	8	-	-	-	100	1
COE 1050 SBS	10	-	-	-	50	1
COE 1250 SBS	12	-	-	-	50	1
COE 1425 SBS	14	-	-	-	25	1
CCI 602 NS	6	2	-	-	-	5
CCI 802 NP	8	2	-	-	-	5
CCI 101 NP	10	1	-	-	-	5
CCI 121 NP	12	1	-	-	-	5

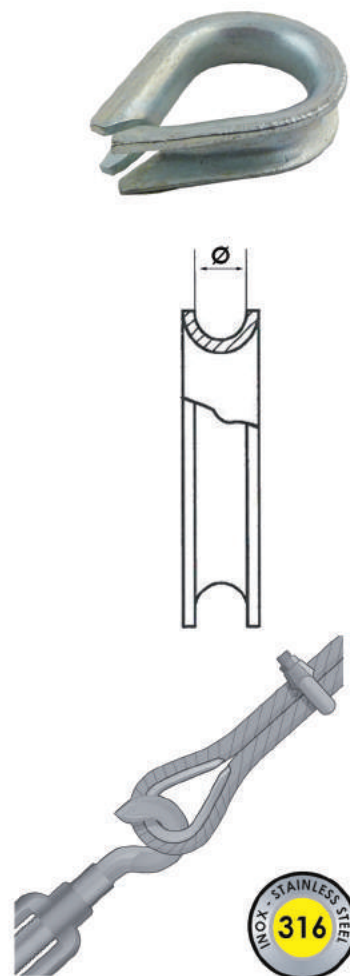



CROCHET DE GYMNASE
GYM HOOK

GANCHO DE GIMNASIO
GANCHO DE GINASTICA

GYMNAKTIKZAAL HAAK

Code	ØA mm	ØB mm	ØC mm	L mm	L2 mm	L3 mm	I mm		
ASE 101 NP	8	10	17	78	100	150	48	1	5

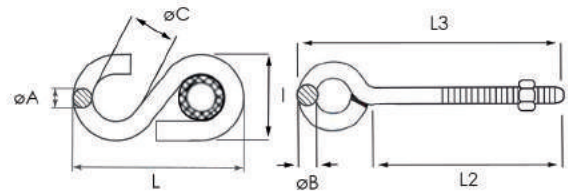

Code	ØA mm	ØB mm	L mm			
QDC 07 E	45	12	70	1	300	5
QDC 15 E	45	12	150	1	300	5

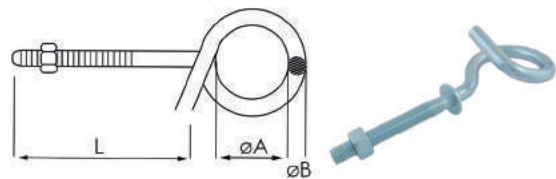

Code	ØA mm	ØB mm	L mm			
QDV 09 E	45	12	90	1	300	5

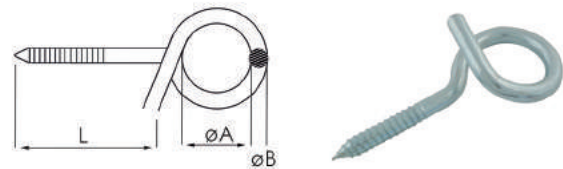

CROCHET À PLATINE
HOOK WITH PLATINIUM

GANCHO CON PLATINO
GANCHO COM PLATINA

HAAK MET PLATINA

Code	ØA mm	ØB mm			
CFP 80 E	20	8	-	1	5
CPV 401 NP	8	-	1	-	5

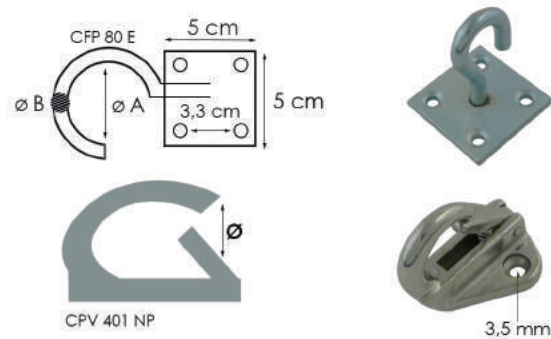

CROCHET DE LEVAGE
LIFTING HOOK

GANCHO DE LEVANTAMIENTO
GANCHO DE LEVANTAMENTO

TILLEN HAAK



Code			
CLE 75 E	750	1	5
CLE 10 E	1000	1	5
CLE 16 E	1500	1	5
CLE 20 E	2000	1	5
LEO 6 E	500	1	5
LEO 8 E	750	1	5
LEO 10 E	1000	1	5





CROCHET DE TRAIT
LINE HOOK

GANCHO DE LINEA
GANCHO DE LINHA

LINJNHAAK

Code	Ø mm	KG		
CRTE 14 E	6-7	400	1	5
CRTE 16 E	8-9	700	1	5
CRTE 18 E	10	800	1	5
CRTE 20 E	12	1150	1	5



Acier poli / Polished steel / Acero pulido / Aço polido / Beleefd staal

CROCHET PLASTIQUE
PLASTIC HOOK

GANCHO PLASTICO
GANCHO PLASTICO

PLASTIC HAAK

Code				
CBF 004 SB	○	-	4	10
CBO 002 NP	○	2	-	5
CBO 004 SB	○	-	4	10
CNF 004 SB	●	-	4	10
CNO 004 SB	●	-	4	10
CRF 004 SB	●	-	4	10
CRO 002 NP	●	2	-	5
CRO 004 SB	●	-	4	10



CROCHET POUR BÂCHE ACIER
TARPAULIN STEEL HOOK

GANCHO PARA TOLDO ACERO
GANCHO TOLDO AÇO

STAAL HAAK

Code	L mm	l mm			
CPB 414 NP	41	15	4	-	5
CPB 722 NP	70	20	2	-	5
CPB 414 SB	41	15	-	4	10



CROCHET ACIER PLASTIFIÉ
HOOK WITH CLIP

GANCHO ACERO PLASTIFICADO
GANCHO AÇO PLÁSTICO

GELAMINEERD STAAL HAAK

Code	Ø mm			
CRS 404 NP	4	4	-	5
CRS 602 NP	6	2	-	5
CRS 802 NP	8	2	-	5
CRS 102 NP	10	2	-	5
CRS 604 SB	6	-	4	10
CRS 804 SB	8	-	4	10







ÉLASTIQUE
ELASTIC

ELASTICA
ELASTICO

ELASTIEK

Code		
BEA 60 NP	60gr	5



Code	L mm	l mm		
ECT 810 NP	80	5	10	5
ECT 1210 NP	120	5	10	5



ESSE INÉGALE ACIER ZINGUÉ
«S» HOOK ZINGED STEEL

GANCHO «S» ACERO GALVANIZADO
GANCHO «S» AÇO GALVANIZADO

HAAK «S» GEGALVANISERD STAAL





Code	ø mm		
EIC 206 NS	2	6	5
EIC 276 NS	2,7	6	5



ESSE ACIER
«S» STEEL HOOK

GANCHO «S» ACERO
GANCHO «S» AÇO

HAAK «S» STAAL

Code	ø mm					
ESS 1810 NS	1,8	10	-	-	-	5
ESS 2510 NS	2,5	10	-	-	-	5
ESS 2550 NP*	2,5	50	-	-	-	5
ESS 2650 NP*	3	50	-	-	-	5
ESS 266 NS	3	6	-	-	-	5
ESS 404 NS	4	4	-	-	-	5
ESS 430 NP*	4	30	-	-	-	5
ESS 502 NS	5	2	-	-	-	5
ESS 525 NP*	5	25	-	-	-	5
ESS 582 NP	6	2	-	-	-	5
ESS 802 NS	8	2	-	-	-	5
ESS 8 E	8	-	-	-	1	5
ESS 251 SB	2,5	-	10	-	-	10
ESS 2610 SB	3	-	10	-	-	10
ESS 410 SB	4	-	10	-	-	10
ESS 510 SB	5	-	10	-	-	10
ESS 18100 SBS	1,8	-	-	100	-	1
ESS 25100 SBS	2,5	-	-	100	-	1
ESS 3100 SBS	3	-	-	100	-	1
ESS 4100 SBS	4	-	-	100	-	1
ESS 5100 SBS	5	-	-	100	-	1
ESS 58100 SBS	6	-	-	100	-	1
ESS 8100 SBS	8	-	-	100	-	1



ESS



* Big bag

ESSE INOX
«S» STAINLESS STEEL HOOK

GANCHO «S» ACERO INOXIDABLE
GANCHO «S» AÇO INOXIDAVEL

HAAK «S» ROESTVRIJ STAAL



Code	∅ mm		
ESI 306 NS	3	6	5
ESI 404 NS	4	4	5
ESI 502 NS	5	2	5



ESSE ACIER
«S» STEEL HOOK

GANCHO «S» ACERO
GANCHO «S» AÇO

HAAK «S» STAAL

Code		∅ mm		
ESB 306 NS		3	6	-
ESL 306 NS		3	6	-
ESN 306 NS		3	6	-
ESNJ 584 NS		6	4	-
ESRW 584 NS		6	4	-
ESJ 584 SB		6	-	4
ESN 584 SB		6	-	4
ESR 584 SB		6	-	4
ESW 584 SB		6	-	4



ESSE. PLASTIQUE
PLASTIC «S» HOOK

GANCHO «S» PLASTICO
GANCHO «S» PLASTICO

PLASTIEK HAAK S

Code		∅ mm		
ENJ 802 NS		8	2	-
ERB 802 NS		8	2	-
ERB 804 SB		8	-	4
EPB 804 SB		8	-	4
EPR 804 SB		8	-	4
EPN 804 SB		8	-	4



ESSE DE PEINTRE
«S» STEELHOOK

GANCHO «S» ACERO
GANCHO «S» AÇO

HAAK «S» STAAL

Code	∅ mm	L mm				
ESP 132 NP	4,5	130	2	-	-	5
ESP 172 NP	6	170	2	-	-	5
ESP 602 NP	6	90	2	-	-	5
ESP 6 E	6	90	-	-	-	1
ESP 602 SB	6	90	-	2	-	10
ESP 6100 SBS	6	90	-	-	100	1
ES 454 NS	4,5	71	4	-	-	5
ES 4525 SB	4,5	71	-	25	-	10









GOUPILLE BÉTA ACIER
SPRING STEEL PIN

PASADOR BETA EN ACERO
LINGUETA BETA DE AÇO

PIN STAAL BETA



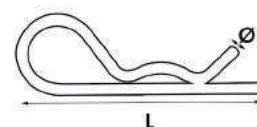

Code	∅ mm	L mm				
GOB 208 NS	2	57	8	-	-	5
GOB 304 NS	3	72	4	-	-	5
GOB 404 NP	4	74	4	-	-	5
GOB 502 NS	5	102	2	-	-	5
GOB 310 SB	3	72	-	10	-	10
GOB 2100 SBS	2	57	-	-	100	1
GOB 3100 SBS	3	72	-	-	100	1
GOB 4100 SBS	4	74	-	-	100	1
GOB 5100 SBS	5	102	-	-	100	1
GOB 650 SBS	6	126	-	-	50	1



GOUPILLE À RESSORT ACIER
TUBE STEEL PIN

PASADOR CON MUELLE ACERO
LINGUETA COM MOLA AÇO

PIN STAAL MET DE LENTE





Code	∅ mm	L mm				
GOR 206 NS	2	57	6	-	-	5
GOR 304 NS	3	73	4	-	-	5
GOR 402 NS	4	94	2	-	-	5
GOR 5 E	5	110	-	-	1	5
GOR 6 E	6	141	-	-	1	5
GOR 2100 SBS	2	57	-	100	-	1
GOR 3100 SBS	3	73	-	100	-	1
GOR 4100 SBS	4	94	-	100	-	1
GOR 5100 SBS	5	110	-	100	-	1
GOR 6100 SBS	6	141	-	100	-	1



GOUPILLE DELTA ACIER
SPRING STEEL PIN

PASADOR DELTA EN ACERO
LINGUETA DELTA DE AÇO

PIN STAAL DELTA

Code	∅ mm	L mm				
GOD 602 NP	6	45	2	-	-	5
GOD 802 NP	8	45	2	-	-	5
GOD 112 NP	11	45	2	-	-	5
GOD 6 E	6	45	-	-	1	5
GOD 11 E	11	45	-	-	1	5
GOD 6100 SBS	6	45	-	100	-	1
GOD 8100 SBS	8	45	-	100	-	1
GOD 1150 SBS	11	45	-	50	-	1

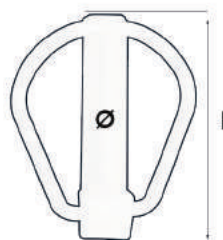



GOUPILLE CLIP ACIER
SPRING STEEL PIN

PASADOR CLIP EN ACERO
LINGUETA CLIP DE AÇO

PIN STAAL CLIP

Code	∅ mm	L mm					
GOC 602 NS	6	41	2	-	-	-	5
GOC 802 NS	8	41	2	-	-	-	5
GOC 902 NP	9	41	2	-	-	-	5
GOC 102 NP	10	41	2	-	-	-	5
GOC 112 NP	11	41	2	-	-	-	5
GOC 6E	6	41	-	-	-	1	5
GOC 8 E	8	41	-	-	-	1	5
GOC 9 E	9	41	-	-	-	1	5
GOC 10 E	10	41	-	-	-	1	5
GOC 804 SB	8	41	-	4	-	-	10
GOC 5100 SBS	4,5	34	-	-	100	-	1
GOC 6100 SBS	6	41	-	-	100	-	1
GOC 7100 SBS	7	41	-	-	100	-	1
GOC 8100 SBS	8	41	-	-	100	-	1
GOC 950 SBS	9	41	-	-	50	-	1
GOC 1050 SBS	10	41	-	-	50	-	1
GOC 1150 SBS	11	41	-	-	50	-	1

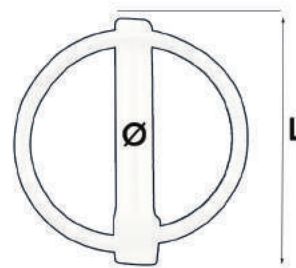

GOUPILLE POUR TUBE ACIER
TUBE STEEL PIN

PASADOR TUBO ACERO
LINGUETA TUBE AÇO

PIN BUIS STAAL

Code	∅ mm	L mm				
GOM 452 NP	4,5	32	2	-	-	5
GOM 602 NP	6	45	2	-	-	5
GOM 842 NP	8	40	2	-	-	5
GOM 802 NP	8	45	2	-	-	5
GOM 862 NP	8	60	2	-	-	5
GOM 152 NP	10	50	2	-	-	5
GOM 162 NP	10	60	2	-	-	5
GOM 451 E	4,5	32	-	-	1	5
GOM 6 E	6	45	-	-	1	5
GOM 48 E	8	40	-	-	1	5
GOM 458 E	8	45	-	-	1	5
GOM 68 E	8	60	-	-	1	5
GOM 15 E	10	50	-	-	1	5
GOM 16 E	10	60	-	-	1	5
GOM 45100 SBS	4,5	32	-	100	-	1
GOM 6100 SBS	6	45	-	100	-	1
GOM 48100 SBS	8	40	-	100	-	1
GOM 458100 SBS	8	45	-	100	-	1
GOM 68100 SBS	8	60	-	100	-	1
GOM 1550 SBS	10	50	-	50	-	1
GOM 1650 SBS	10	60	-	50	-	1

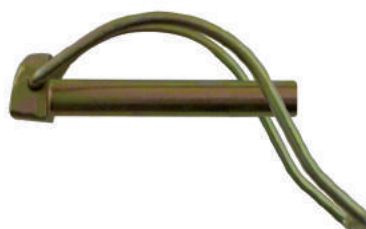
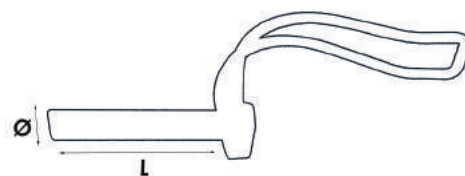



GOUPILLE AGRICOLE ACIER
SPRING STEEL PIN

PASADOR AGRÍCOLA ACERO
LINGUETA AGRÍCOLA AÇO

PIN STAAL LANDBOUW

Code	∅ mm	L mm				
GOT 951 NP	9,5	64	1	-	-	5
GOT 95 E	9,5	64	-	-	1	5
GOT 9550 SBS	9,5	64	-	50	-	1

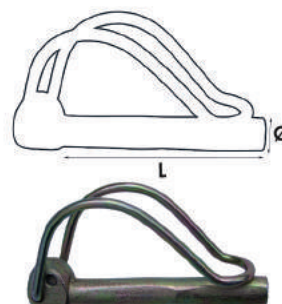

GOUPILLE ARCEAU ACIER
«D» TYPE STEEL PIN

PASADOR CON ARCO EN ACERO
LINGUETA ARO DE AÇO

PIN STAAL MET BOOG

Code	∅ mm	L mm			
GOA 602 NP	6	45	2	-	5
GOA 802 NP	8	38	2	-	5
GOA 952 NP	9,5	38	2	-	5
GOA 6100 SBS	6	45	-	100	1
GOA 8100 SBS	8	38	-	100	1
GOA 9550 SBS	9,5	38	-	50	1
GOA 95750 SBS	9,5	57	-	50	1

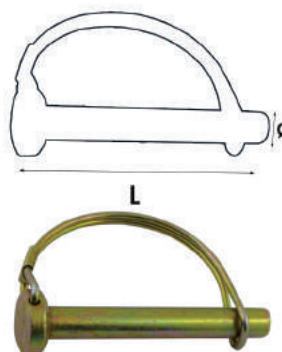

GOUPILLE ÉLASTIQUE
ELASTIC PIN

PASADOR ELÁSTICO
LINGUETA ELÁSTICO

PIN ELASTISCH

Code	∅ mm	L mm			
GOE 210 NP	2	30	10	-	5
GOE 2510 NP	2,5	30	10	-	5
GOE 35 NP	3	40	5	-	5
GOE 45 NP	4	50	5	-	5
GOE 2100 SBS	2	30	-	100	1
GOE 25100 SBS	2,5	30	-	100	1
GOE 3100 SBS	3	40	-	100	1
GOE 450 SBS	4	50	-	50	1
GOE 550 SBS	5	50	-	50	1
GOE 650 SBS	6	60	-	50	1
GOE 6850 SBS	6	80	-	50	1
GOE 7850 SBS	7	80	-	50	1
GOE 8850 SBS	8	80	-	50	1
GOE 1650 SBS	10	60	-	50	1
GOE 1825 SBS	10	80	-	25	1
GOE 2625 SBS	12	60	-	25	1
GOE 2825 SBS	12	80	-	25	1

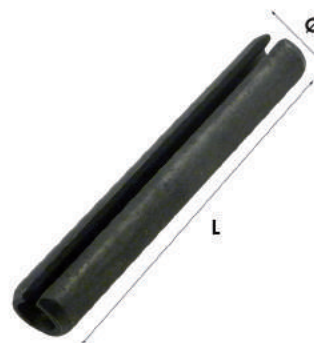



GOUPILLE ARCEAU ACIER
«D» TYPE STEEL PIN

PASADOR CON ARCO EN ACERO
LINGUETA ARO DE AÇO

PIN STAAL MET BOOG

Code	∅ mm	L mm				
GOS 802 NP	8	64	2	-	-	5
GOS 952 NP	9,5	57	2	-	-	5
GOS 6100 SBS	6	45	-	100	-	1
GOS 850 SBS	8	64	-	50	-	1
GOS 9550 SBS	9,5	57	-	50	-	1
GOS 6 E	6	45	-	-	1	5

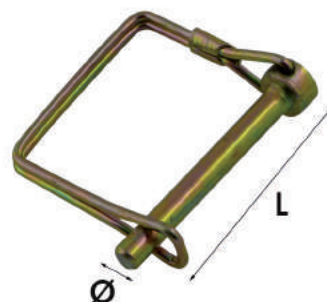

GOUPILLE FENDUE ACIER
SPLIT STEEL PIN

PASADOR HENDIDO ACERO
LINGUETA FENDIDA AÇO

PIN MET GLEUF STAAL

Code	∅ mm	L mm		
GOF 220 NS	2	32	20	5
GOF 3220 NS	3,2	32	20	5
GOF 410 NS	4	36	10	5



GOUPILLE ACIER BICHROMATÉ
BICHROMATED STEEL PIN

PASADOR BICROMADO
LINGUETA BICHROMADO

TWEEVOUDIJE STAAL PIN

Code	∅ mm	L mm		
GST 1550 SBS	16	60	50	5

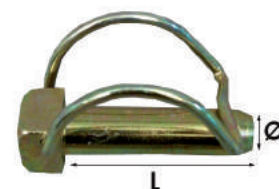

HUIT DE RÉGLAGE ACIER
STEEL EIGHT OF ADJUSTMENT

OCHO DE ACERO
OITO DE AÇO

ACHT VAN AANPASSING STAAL

Code	∅ mm		
HDR 072 NS	13	2	5

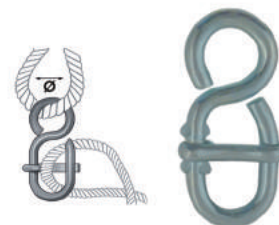

MAILLON À VISSER GRANDE OUVERTURE
QUICK LINK LARGE OPENING

ESLABÓN A ATORNILLAR GRAN APERTURA
LIGAÇÃO APARAFUSAR GRANDE ABERTURA

SCHAKEL GROTE OPENINGSTAAL ROESTVRIJ

Code	∅ mm	KG		
MRGI 402 NS	4	90	2	5
MRGI 601 NS	6	200	1	5
MRGI 801 NP	8	350	1	5
MRGI 101 NP	10	550	1	5

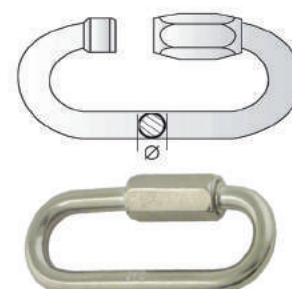

MAILLON À VISSER INOX
STAINLESS STEEL QUICK LINK

ESLABÓN A ATORNILLAR ACERO INOXIDABLE
LIGAÇÃO APARAFUSAR AÇO INOXIDAVEL

SCHAKEL STAAL ROESTVRIJ



Code	∅ mm	KG		
MRI 402 NS	4	90	2	5
MRI 602 NS	6	200	2	5
MRI 801 NP	8	350	1	5
MRI 101 NP	10	550	1	5

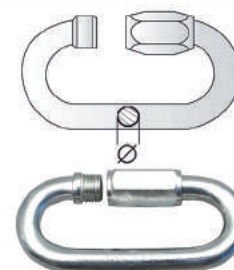

MAILLON À VISSER ACIER
STEEL QUICK LINK

ESLABÓN A ATORNILLAR ACERO
LIGAÇÃO APARAFUSAR AÇO

SCHAKEL STAAL

Code	∅ mm	KG					
MRA 3520 NP *	3,5	50	20	-	-	-	5
MRA 354 NS	3,5	50	4	-	-	-	5
MRA 404 NS	4	90	4	-	-	-	5
MRA 502 NS	5	140	2	-	-	-	5
MRA 510 NP *	5	140	10	-	-	-	5
MRA 602 NS	6	200	2	-	-	-	5
MRA 701 NS	7	275	1	-	-	-	5
MRA 710 NP *	7	275	10	-	-	-	5
MRA 801 NS	8	350	1	-	-	-	5
MRA 101 NP	10	550	1	-	-	-	5
MRA 121 NP	12	750	1	-	-	-	5
MRA 141 NP	14	1100	1	-	-	-	5
MRA 5 E	5	140	-	-	-	1	5
MRA 6 E	6	200	-	-	-	1	5
MRA 7 E	7	275	-	-	-	1	5
MRA 8 E	8	350	-	-	-	1	5
MRA 10 E	10	550	-	-	-	1	5
MRA 12 E	12	750	-	-	-	1	5
MRA 14 E	14	1100	-	-	-	1	5
MRA 355 SB	3	50	-	5	-	-	10
MRA 045 SB	4	90	-	5	-	-	10
MRA 055 SB	5	140	-	5	-	-	10
MRA 062 SB	6	200	-	2	-	-	10
MRA 082 SB	8	350	-	2	-	-	10
MRA 102 SB	10	550	-	2	-	-	10
MRA 35100 SBS	3,5	50	-	-	100	-	1
MRA 4100 SBS	4	90	-	-	100	-	1
MRA 5100 SBS	5	140	-	-	100	-	1
MRA 6100 SBS	6	200	-	-	100	-	1
MRA 7100 SBS	7	275	-	-	100	-	1
MRA 8100 SBS	8	350	-	-	100	-	1
MRA 1050 SBS	10	550	-	-	50	-	1
MRA 1250 SBS	12	750	-	-	20	-	1

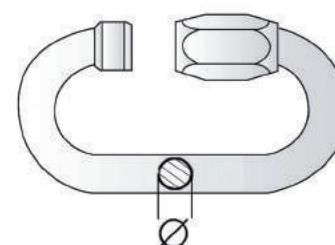

* BIG BAG



MAILLON À VISSER PLASTIQUE
PLASTIC QUICK LINK

ESLABÓN A ATORNILLAR PLASTICO
LIGAÇÃO APARAFUSAR PLASTICO

SCHAKEL PLASTIEK

Code	∅ mm				
MNJ 802 NS	6 - 8		2	-	5
MRP 802 NS	6 - 8		2	-	5
MRB 804 SB	6 - 8		-	4	10
MRJ 804 SB	6 - 8		-	4	10
MRN 804 SB	6 - 8		-	4	10
MRP 804 SB	6 - 8		-	4	10
MRR 804 SB	6 - 8		-	4	10



MAILLON À VISSER ACIER
STEEL QUICK LINK

ESLABÓN A ATORNILLAR ACERO
LIGAÇÃO APARAFUSAR ACO

SCHAKEL STAAL

Code	∅ mm				
MRAB 604 SB	6		4	-	10
MRABL 604 SB	6		4	-	10
MRAJ 604 SB	6		4	-	10
MRAN 604 SB	6		4	-	10
MRAR 604 SB	6		4	-	10
MRAV 604 SB	6		4	-	10



MAILLE PLASTIQUE
PLASTIC MESH

MALLA DE PLASTICO
MALHA PLASTICO

GAAS PLASTIEK

Code	∅ mm				
APB 804 SB	8		4	-	10
APN 804 SB	8		4	-	10
APR 804 SB	8		4	-	10



MANCHON ALUMINIUM
ALUMINIUM SLEEVE CLIP

MANGUITO ALUMINIO
MANGA APERTO ALUMINIO

ALUMINIUM BESCHERMHULS

Code	∅ mm			
MPC 210 NS	2	10	-	5
MPC 306 NS	3	6	-	5
MPC 404 NS	4	4	-	5
MPC 502 NS	5	2	-	5

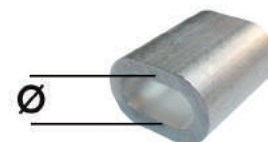



MANILLE DROITE ACIER
STEEL SHACKLE

GRILLETE RECTO STANDARD ACERO
MANILA DIREITO DE AÇO

BEUGEL RECHTS STAAL



Code	ø mm	KG					
MAN 404 NS	4	80	4	-	-	-	5
MAN 602 NS	6	100	2	-	-	-	5
MAN 802 NP	8	200	2	-	-	-	5
MAN 102 NP	10	320	2	-	-	-	5
MAN 121 NP	11	520	1	-	-	-	5
MAN 141 NP	13	650	1	-	-	-	5
MAN 6 E	6	100	-	-	-	1	5
MAN 8 E	8	200	-	-	-	1	5
MAN 10 E	10	320	-	-	-	1	5
MAN 12 E	11	520	-	-	-	1	5
MAN 14 E	13	650	-	-	-	1	5
MAN 16 E	16	1600	-	-	-	1	5
MAN 20 E	20	2000	-	-	-	1	5
MAN 25 E	25	3000	-	-	-	1	5
MAN 32 E	32	4000	-	-	-	1	5
MAN 082 SB	8	200	-	2	-	-	10
MAN 102 SB	10	320	-	2	-	-	10
MAN 122 SB	12	520	-	2	-	-	10
MAN 4100 SBS	4	80	-	-	100	-	1
MAN 6100 SBS	6	100	-	-	100	-	1
MAN 8100 SBS	8	200	-	-	100	-	1
MAN 1050 SBS	10	320	-	-	50	-	1

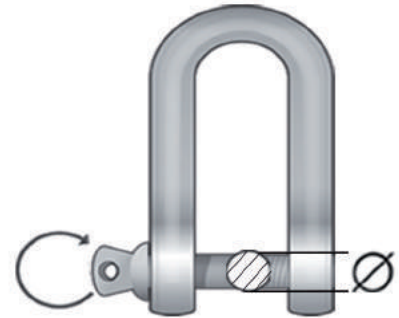

MANILLE DROITE ACIER
STEEL SHACKLE

GRILLETE RECTO STANDARD ACERO
MANILA DIREITO DE AÇO

BEUGEL RECHTS STAAL



Code	ø mm	KG			
MAT 502 NS	5	100	2	-	5
MAT 602 NS	6	160	2	-	5
MAT 802 NP	8	250	2	-	5
MAT 102 NP	10	400	2	-	5
MAT 121 NP	12	630	1	-	5
MAT 141 NP	14	800	1	-	5
MAT 16 E	16	1000	-	1	5
MAT 20 E	20	1600	-	1	5

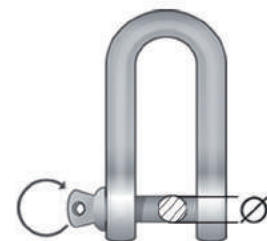



MANILLE DROITE ACIER INOXYDABLE
STAINLESS STEEL SHACKLE

GRILLETE RECTO ACERO INOXIDABLE
MANILA DIREITO DE AÇO INOXIDAVEL

BEUGEL ROESTVAST STAAL



Code	ø mm	kg		
MDI 402 NS	4	50	2	5
MDI 602 NS	6	100	2	5
MDI 801 NP	8	200	1	5
MDI 101 NP	10	320	1	5
MDI 121 NP	12	520	1	5

MANILLE LONGUE ACIER INOXYDABLE
STAINLESS STEEL LONG SHACKLE

GRILLETE LARGO ACERO INOXIDABLE
MANILA LONGO DE AÇO INOXIDAVEL

BEUGEL ROESTVAST STAAL



Code	ø mm	L mm	kg		
MIL 402 NS	4	30	50	2	5
MIL 502 NS	5	37	80	2	5
MIL 602 NS	6	45	100	2	5
MIL 801 NP	8	60	200	1	5
MIL 101 NP	10	75	320	1	5

MANILLE LYRE ACIER
STEEL BOW SHACKLE

GRILLETE LIRA ACERO
MANILA LIRA AÇO

BEUGEL STAAL

Code	ø mm	kg				
MLH 502 NS	8	500	2	-	-	5
MLH 752 NS	10	750	2	-	-	5
MLH 101 NP	11	1000	1	-	-	5
MLH 151 NP	13	1500	1	-	-	5
MLH 5100 SBS	8	500	-	100	-	1
MLH 7550 SBS	10	750	-	50	-	1
MLH 1050 SBS	11	1000	-	50	-	1
MLH 1550 SBS	13	1500	-	50	-	1
MLH 5 E	8	500	-	-	1	5
MLH 75 E	10	750	-	-	1	5
MLH 10 E	11	1000	-	-	1	5
MLH 15 E	13	1500	-	-	1	5
MLH 20 E	17	2000	-	-	1	5

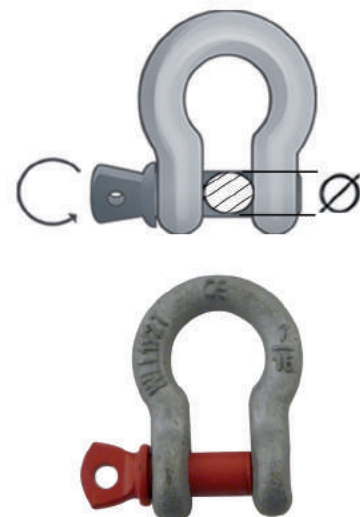



MANILLE LYRE INOX
STAINLESS STEEL BOW SHACKLE

GRILLETE LIRA ACERO INOXIDABLE
MANILA LIRA AÇO INOXIDAVEL

BEUGEL STAAL ROESTVRIJ



Code	ø mm	kg		
MLI 402 NS	4	50	2	5
MLI 601 NS	6	100	1	5
MLI 801 NP	8	200	1	5
MLI 101 NP	10	320	1	5

MANILLE LONGUE ACIER INOXIDABLE
STAINLESS STEEL LONG SHACKLE

GRILLETE LARGO ACERO INOXIDABLE
MANILA LONGO DE AÇO INOXIDAVEL

BEUGEL ROESTVAST STAAL



Code	ø mm	kg		
MTI 041 NS	4	50	1	5
MTI 061 NS	6	100	1	5

MOUSQUETON ACIER
STEEL SNAP HOOK

MOSQUETÃO ACERO
MOSQUETÃO AÇO

KARABIJNHAAK STAAL

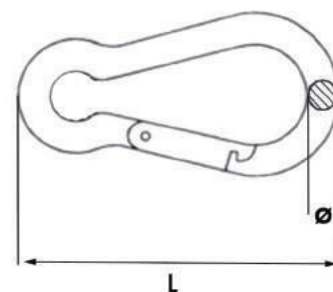

Code	ø mm	L mm	kg					
MAL 404 NS	4	40	70	4	-	-	-	5
MAL 502 NS	5	50	100	2	-	-	-	5
MAL 602 NS	6	60	120	2	-	-	-	5
MAL 802 NS	8	80	230	2	-	-	-	5
MAL 101 NP	10	100	350	1	-	-	-	5
MAL 5 E	5	50	100	-	-	-	1	5
MAL 6 E	6	60	120	-	-	-	1	5
MAL 8 E	8	80	230	-	-	-	1	5
MAL 10 E	10	100	350	-	-	-	1	5
MAL 042 SB	4	40	70	-	2	-	-	10
MAL 052 SB	5	50	100	-	2	-	-	10
MAL 062 SB	6	60	120	-	2	-	-	10
MAL 082 SB	8	80	230	-	2	-	-	10
MAL 4100 SBS	4	40	70	-	-	100	-	5
MAL 5100 SBS	5	50	100	-	-	100	-	5
MAL 6100 SBS	6	60	120	-	-	100	-	5
MAL 8100 SBS	8	80	230	-	-	100	-	5
MAL 1050 SBS	10	100	350	-	-	50	-	5



MOUSQUETON INOX
STAINLESS STEEL SNAP HOOK

MOSQUETON ACERO INOXIDABLE
MOSQUETÃO AÇO INOXIDAVEL

KARABIJNHAAK STAAL RORSTVRIEJ



Code	∅ mm	L mm	kg		
MAI 502 NS	5	50	100	2	5
MAI 602 NS	6	60	120	2	5
MAI 801 NP	8	80	230	1	5
MAI 101 NP	10	100	350	1	5



MOUSQUETON À OEIL INOX
STAINLESS STEEL SNAP HOOK WITH EYELET

MOSQUETON CON OJO ACERO INOXIDABLE
MOSQUETÃO COM OLHO AÇO INOXIDAVEL

KARABIJNHAAK OGEN STAAL RORSTVRIEJ



Code	∅A mm	∅B mm	L mm	kg		
MAE 801 NP	12	8	80	230	1	5
MAE 101 NP	15	10	100	350	1	5

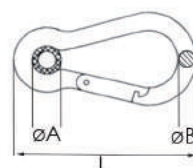

MOUSQUETON À OEIL
SNAP HOOK WITH EYELET

MOSQUETON CON OJO
MOSQUETÃO COM OLHO

KARABIJNHAAK OGEN



Code	∅A mm	∅B mm	L mm	kg		
MAO 502 NS	8	5	50	100	2	5
MAO 602 NS	9	6	60	120	2	5
MAO 802 NS	12	8	80	230	2	5
MAO 101 NP	15	10	100	350	1	5

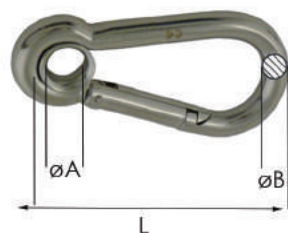

MOUSQUETON À OEIL + S
SNAP HOOK WITH EYELET + S

MOSQUETON CON OJO + S
MOSQUETÃO COM OLHO + S

KARABIJNHAAK OGEN + S



Code	∅A mm	∅B mm	∅C mm	L mm	L2 mm	l mm		
MAS 101 NP	8	22	10	70	100	38	1	5

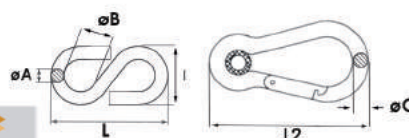



MOUSQUETON À POMPE ZAMAK
ZAMAK SNAP HOOK

MOSQUETON ZAMAK BOMBA DE CARRETE
MOSQUETÃO ZAMAK BOMBA COM TORNO

ZAMAK KARABIJNHAAK POMP

Code	L mm				
MCN 702 NP	72	2	-	-	5
MPN 802 NS	80	2	-	-	5
MPN 111 NS	100	1	-	-	5
PCE 554 NS	53	4	-	-	5
MPN 11 E	100	-	-	1	5
MCN 702 SB	72	-	2	-	10
MPN 082 SB	80	-	2	-	5
MPN 112 SB	100	-	2	-	5

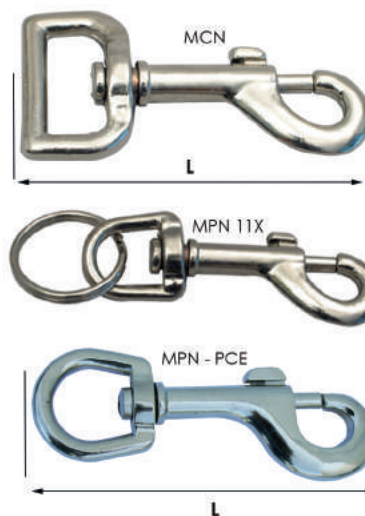

MOUSQUETON ACIER AVEC VIS
STEEL SNAP HOOK WITH SCREW

MOSQUETON ACERO CON VIROLA
MOSQUETÃO AÇO COM PARAFUSO

KARABIJNHAAK STAAL SCHROEF



Code	Ø mm	L mm			
MSE 101 NP	10	100	1	-	5
MSE 121 NP	12	140	1	-	5
MSE 10 E	10	100	-	1	1

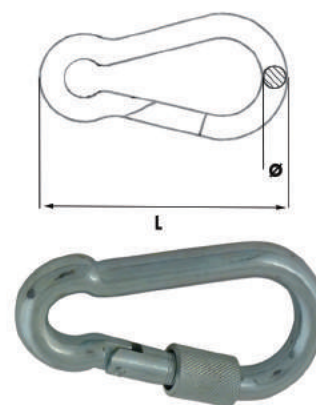

MOUSQUETON POUR DRISSE INOX
STAINLESS STEEL SNAP HOOK FOR HALYARD

MOSQUETON DRIZA ACERO INOXIDABLE
MOSQUETÃO OSTAGA AÇO INOXIDAVEL

KARABIJNHAAK VAL STAAL RORSTVRIEJ



Code	L mm	kg		
MEI 701 NP	70	-	1	5
MEI 871 NP	87	-	1	5
MOI 521 NS	52	345	1	5





MOUSQUETON SÉCURITÉ ACIER
STEEL SECURITY SNAP HOOK

MOSQUETON ACERO DE SEGURIDAD
MOSQUETÃO AÇO DE SEGURANÇA

KARABIJNHAAK STAAL VEILIGHEID



Code	L mm			
PMS 051 NS *	55	1	200	5
PMS 111 NP	85	1	350	5
MTS 131 NS **	110	1	-	5



* Bichromaté / Bichromated / Bicromado / Verchroomd

** Nickelé / Nickel plated / Niquelado / Vernikkeld

MOUSQUETON SIMPLEX ACIER
STEEL SNAP HOOK

MOSQUETON DE CARRETE ACERO
MOSQUETÃO AÇO

KARABIJNHAAK STAAL



Code	L mm				
MOU 304 NS	30	4	-	-	5
MOU 404 NS	40	4	-	-	5
MOU 504 NS	50	4	-	-	5
MOU 602 NS	60	2	-	-	5
MOU 801 NS	80	1	-	-	5
MOU 101 NS	100	1	-	-	5
MOU 121 NS	120	1	-	-	5
MOU 065 SB	60	-	5	-	5

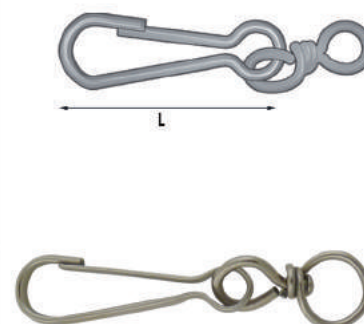

MOUSQUETON
SNAP HOOK

MOSQUETON
MOSQUETÃO

KARABIJNHAAK



Code	L mm			
MAB 7351 NP **	70	1	-	5
MPCP 801 NP *	80	1	-	5
PCA 702 NS **	80	2	-	5
PSA 702 NS **	70	2	-	5
MAB 735 E **	70	-	1	5
MPCP 80 E *	80	-	1	5
PCA 70 E **	80	-	1	5
PSA 70 E **	70	-	1	5



* Plastique / Plastic / Plastico / Plastiek ** Aluminium



OEILLET ACIER POUR BÂCHE
EYELET FOR TARPAULIN

OJETES TOLDOS ACERO
CRAVO PARA COBERTA

ANJER VOOR WATERRESERVOIR

Code	Ø mm			
OB 125 NP	12	25	-	5
OB 120 SB	12	-	20	10



PINCE RESSORT
SPRING CLIP

PINZA RESSORTE
PINÇA MOLA

TANG VEER

Code	Ø mm		
PR 686 NS	6 → 8	6	5
PR 9116 NS	9 → 11	6	5
PR 12162 NS	12 → 16	2	5
PR 23292 NS	23 → 29	2	5
PR 30371 NP	30 → 37	1	5
PR 36481 NP	36 → 48	1	5

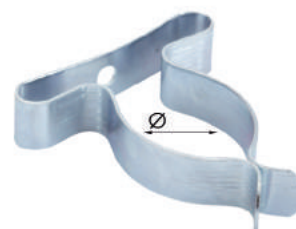

PIQUET DE CAMPING ACIER
STEEL PEG

PIQUETA DE CAMPING ACERO
PIQUETE CAMPISMO AÇO

STAAL PIN KAMPEERTERRAIN

Code	L mm		
PCO 1810 NP	180	10	5
PCO 2310 NP	230	10	5
PFI 1810 NP	180	10	5
PFI 2410 NP	240	10	5

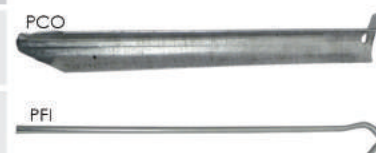

PLATINE À OEIL
STEEL LONG EYE PLATE

PLATINA CON OJO ACERO
PLATINA A OLHO AÇO

STAAL LANGE OOGPLAAT



Code	Ø mm	L mm	l mm		
POI 452 NS *	5	45	15	2	5
POI 602 NP *	6	60	20	2	5
POI 801 NP *	8	80	26	1	5
POZ 601 NS	6	60	20	1	5

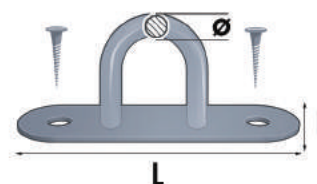



PORTE CLÉS / KEY RING **LLAVERO / CHAVEIRO** **SLEUTELHANGER**

Code	L mm			
PCF 102 NP	120	2	-	5
PCF 100 E	120	-	1	5
PCPR 102 NP	-	2	-	5
PCPR 10 E	-	-	1	5
PCX 100 NP	60	1	-	5
PCX 10 E	60	-	1	5



PORTE ÉTIQUETTE / LABEL HOLDER **PORTAETIQUETAS / SUPPORTE ETIQUETAS** **ETIKETHOUDER**

Code				
PCP 10 NP	10	-	-	5
PCP 201 SB	-	20	-	10
PCR 552 NS	2	-	-	5
PCR 553 E	-	-	1	1

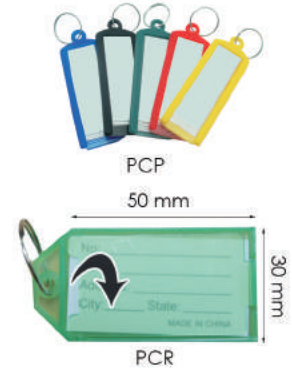

POULIE À CHARNIÈRE 1 GALET / SINGLE PULLEY **POLEA BISAGRA 1 RODILLO ACERO / TALHA 1 SEIXO** **KATROL EEN WAL**

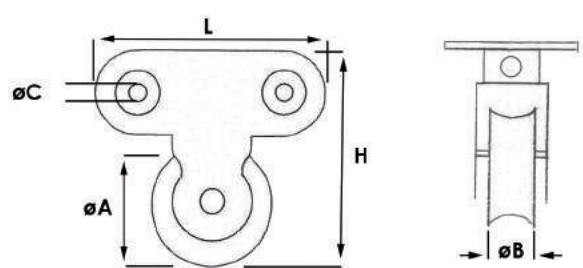

Code	øA mm	øB mm	øC mm	L mm	H mm		
PCG 041 NP	40	6 / 8	5	76	70	1	5

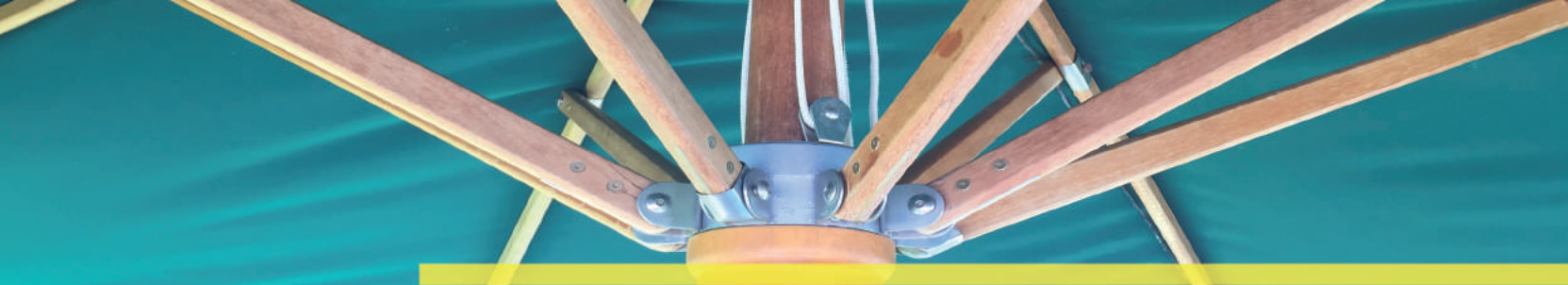

POULIE À CROCHET PIVOTANT
SWIVELLING HOOK PULLEY

POLEA CON GANCHO GIRATORIO
TALHA COM GANCHO ENDOSSÁVEL

KATROL MET DRAAIBARE HAAK

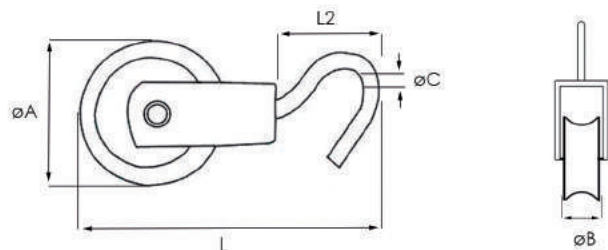

Polyamide / Poliamida

Code	$\varnothing A$ mm	$\varnothing B$ mm	$\varnothing C$ mm	L mm	L2 mm				
PAC 041 NP	40	6	4	85	30	20	1	-	5
PAC 041 SB	40	6	4	85	30	20	-	1	10
PAC 061 NP	60	6	5	110	40	30	1	-	5

POULIE À ÉMERILLON 1 GALET ZAMAK
PULLEY WITH ZAMAK SWIVEL EYE

POLEA A ESMEREJÓN 1 RODILLO ZAMAK
TALHA COM RODE 1 SEIXO ZAMAK

KATROL SWIVEL ZAMAK

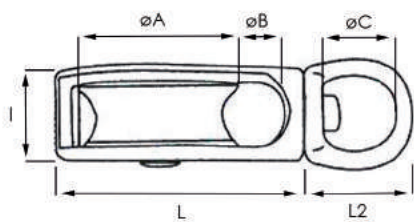

Zamak

Code	$\varnothing A$ mm	$\varnothing B$ mm	$\varnothing C$ mm	L1 mm	L2 mm	I mm			
PSP 252 NS	25	6	10	38	18	15	90	2	5

POULIE À OEIL FIXE 1 GALET
PULLEY WITH EYE

POLEA A OJO FIJO 1 RODILLO
TALHA COM OLHO FIXO 1 SEIXO

KATROL VAST OOG 1 ROLLEN

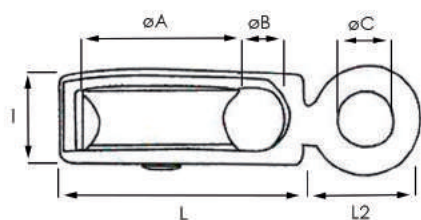

Polyamide
Poliamida

Zamak

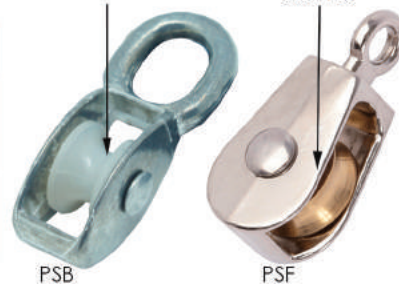

PSB

PSF

Code	$\varnothing A$ mm	$\varnothing B$ mm	$\varnothing C$ mm	L1 mm	L2 mm	I mm			
PSB 152 NS	15	6	14	28	18	14	30	2	5
PSB 252 NP	25	7	17	40	30	18	30	2	5
PSF 371 NP	37	8	10	50	25	17	100	1	5
PSF 371 SB	37	8	10	50	25	17	100	-	10



POULIE À OEIL FIXE 2 GALETS
DOUBLE PULLEY WITH EYE

POLEA A OJO FIJO 2 RODILLOS
TALHA COM OLHO FIXO 2 SEIXOS

KATROL VAST OOG TWEE ROLLEN

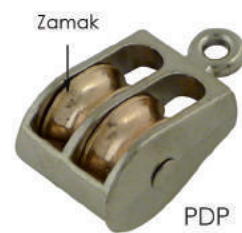
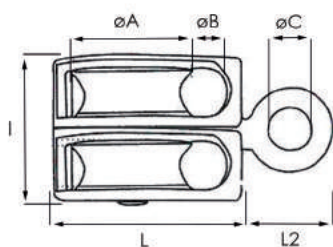

Code	$\varnothing A$ mm	$\varnothing B$ mm	$\varnothing C$ mm	L1 mm	L2 mm	l mm	kg		
PDP 252 NP	25	6	5	38	12	25	100	2	5
PDB 301 NP	30	8	20	50	25	34	100	1	5

POULIE À PITON
SCREWING PULLEY

POLEA CON TORNILLO
TALHA COM PARAFUSO

KATROL MET OOGJE

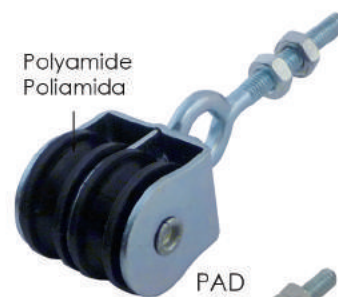
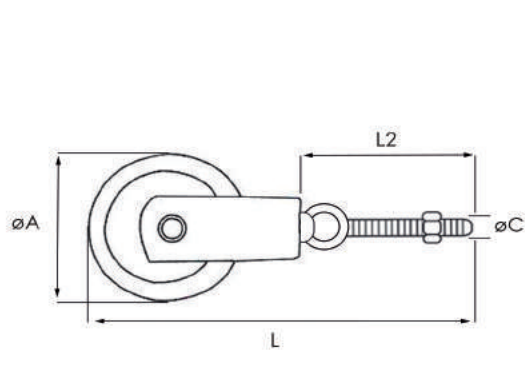

Code	$\varnothing A$ mm	$\varnothing B$ mm	$\varnothing C$ mm	L mm	L2 mm	kg		
PAD 201 NS	20	4	4	70	40	22	1	5
PAS 202 NS	20	4	4	70	40	22	2	5
PAT 041 NP	20	6	6	93	40	36	1	5



POULIE À PLATINE VISSABLE
PULLEY TO SCREW

POLEA PLATINA ENROSCAR 1 RODILLO
TALHA PARA ENROLAR 1 ROLO

KATROL 1 ROLLEN

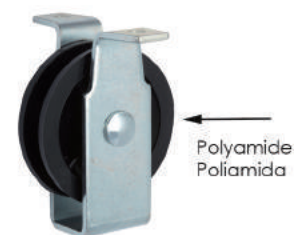
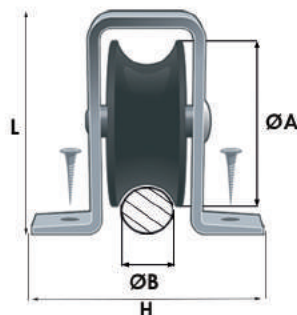

Code	ØA mm	ØB mm	L mm	H mm		
PPV 041 NP	35	6	45	50	1	5

POULIE SÈCHE LINGE
PULLEY TO SCREW

POLEA TENDEDERO DE ACERO
TALHA TENDEDERO DE AÇO

WASTDROGER KATROL

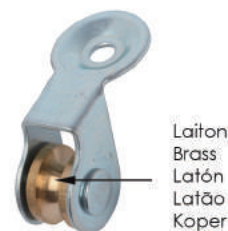
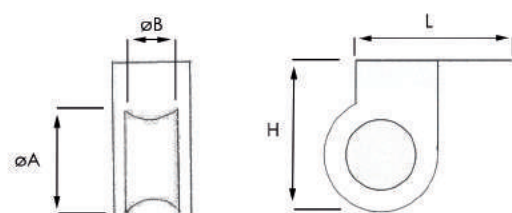

Code	ØA mm	ØB mm	L mm	H mm			
PSL 122 NS	12	4	24	18	40	2	5

POULIE DE HISSAGE
HOISTING PULLEY

POLEA DE ELEVACION CON GANCHO
TALHA DE ELEVACÃO COM GANCHO

OPHANGEN KATROL

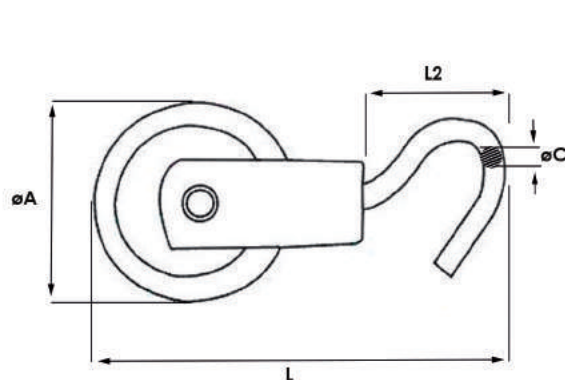

Code	ØA mm	ØB mm	ØC mm	L mm	L2 mm					
PHF 75 E	75	15	12	190	85	400	1200	-	1	1
PHP 501 NP	50	10	5	100	40	120	-	1	-	5



POULIE DE HISSAGE
HOISTING PULLEY

POLEA DE ELEVACION CON GANCHO
TALHA DE ELEVAÇÃO COM GANCHO

OPHANGEN KATROL

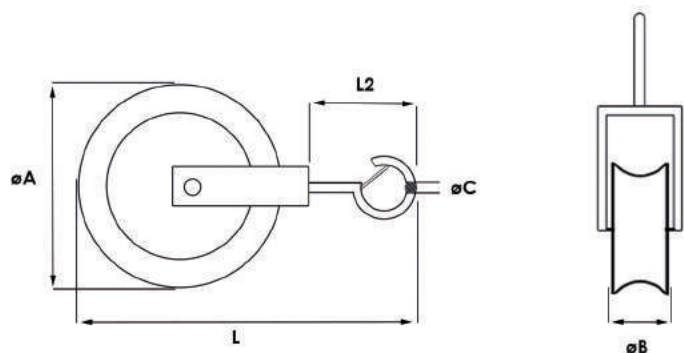

Fonte / Cast Iron /
Hierro / Ferro fundido/
Gemaakt

Code	ØA mm	ØB mm	ØC mm	L mm	L2 mm				
PPF 16 E	160	25	12	300	100	400	1200	1	1

POULIE CLIC
HOISTING PULLEY

POLEA DE ELEVACION CON GANCHO
TALHA DE ELEVAÇÃO COM GANCHO

OPHANGEN KATROL

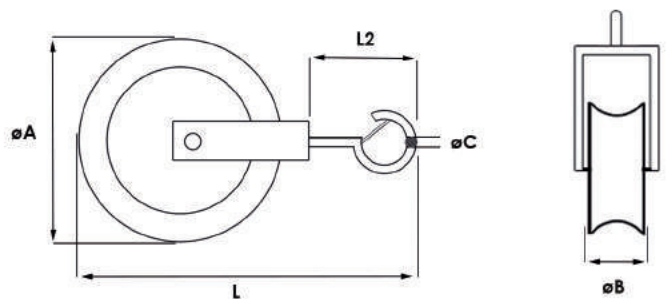

Polyamide / poliamida

Anti-retour / Non-retour / Antirretorno / Anti-retorno / Terugslagklep

Code	ØA mm	ØB mm	ØC mm	L mm	L2 mm				
PCLIC	200	20/30	18	430	70	80	160	1	1

Voir / See / Ver / Veja / Zie «CCP 301 SB» P.28

RESSORT DE COMPRESSION
COMPRESSION SPRING

RESORTE DE COMPRESIÓN
MOLA DE COMPRESÃO

COMPRESSIE VEER

Code	ØA mm	ØB mm	L mm		
RCO 3010 NS	0,4	5	30	10	5
RCO 4010 NS	0,65	5	40	10	5
RCO 606 NS	0,8	6	60	6	5
RCO 806 NS	0,8	8	80	6	5
RCO 705 NS	1	10	70	5	5
RCO 1002 NS	1,8	16	100	2	5

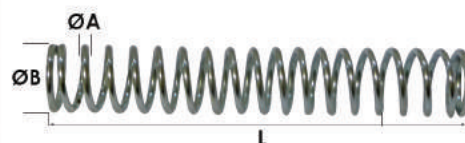



RESSORT DE TRACTION
TRACTION SPRING

RESORTE DE TRACCIÓN
MOLA DE TRACÇÃO

TRACTIE VEER

Code	øA mm	øB mm	L mm		
RTR 453 NS	0,7	7	45	3	5
RTR 303 NS	1	7	30	3	5
RTR 752 NS	1	8,5	75	2	5
RTR 1101 NS	1,8	18	110	1	5
RTSC 628 NP	1,8	13,5	37	8	5
RTS 556 NP	2,5	18	24	6	5
RTS 754 NP	3	18	44	4	5

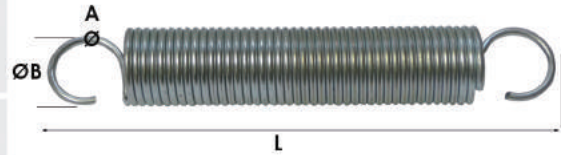

SERRE-CÂBLE PLAT ACIER
STEEL WIRE ROPE CLIP

SUJETACABLE PLANO ACERO
SERRA CABO PLANO AÇO

STAAL KABLECLIP

Code	ø mm			
SCP 124 NS	2	4	-	5
SCP 144 NS	4	4	-	5
SCP 162 NP	6	2	-	5
SCP 124 SB	2	-	4	10
SCP 144 SB	4	-	4	10
SCP 204 NS*	2	4	-	5
SCP 402 NS*	4	2	-	5
SCP 602 NS*	6	2	-	5

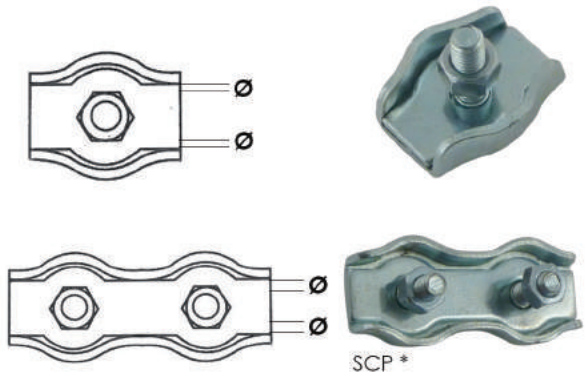

SERRE-CÂBLE PLAT INOX
STAINLESS STEEL WIRE ROPE CLIP

SUJETACABLE PLANO ACERO INOXIDABLE
SERRA CABO PLANO AÇO INOXIDAVEL

ROESTVRIEJ STAAL KABLECLIP



Code	ø mm		
SCPI 032 NS	3	2	5
SCPI 042 NS	4	2	5

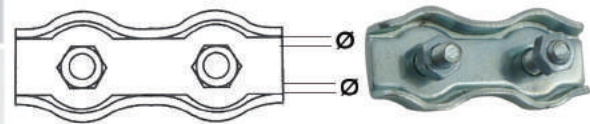

SERRE-CÂBLE VÉLO
STEEL WIRE ROPE CLIP

SUJETACABLE BICI ACERO
SERRA CABO AÇO

STAAL KABLECLIP

Code	ø mm		
SEV 206 NS	2	6	5
SEV 256 NS	2,5	6	5
SEV 306 NS	3	6	5
SEV 356 NS	3,5	6	5

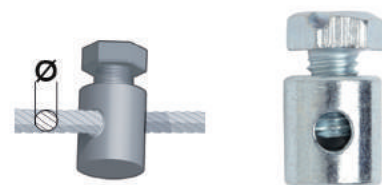



SERRE-CÂBLE ÉTRIER ACIER
STEEL WIRE ROPE CLIP

SUJETACABLE ESTRIBO ACERO
SERRA CABO AÇO

STAAL KABLECLIP

Code	∅ mm					
SER 026 NS	2-3	6	-	-	-	5
SER 044 NS	4-5	4	-	-	-	5
SER 430 NP *	4-5	30	-	-	-	5
SER 062 NS	6	2	-	-	-	5
SER 625 NP *	6	25	-	-	-	5
SER 082 NS	8	2	-	-	-	5
SER 815 NP *	8	15	-	-	-	5
SER 102 NP	10	2	-	-	-	5
SER 108 NP *	10	8	-	-	-	5
SER 122 NP	12	2	-	-	-	5
SER 141 NP	14	1	-	-	-	5
SER 161 NP	16	1	-	-	-	5
SER 201 NP	20	1	-	-	-	5
SER 6 E	6	-	-	-	1	5
SER 8 E	8	-	-	-	1	5
SER 10 E	10	-	-	-	1	5
SER 12 E	12	-	-	-	1	5
SER 14 E	14	-	-	-	1	5
SER 16 E	16	-	-	-	1	5
SER 20 E	20	-	-	-	1	5
SER 204 SB	2-3	-	4	-	-	10
SER 404 SB	4-5	-	4	-	-	10
SER 064 SB	6	-	4	-	-	10
SER 085 SB	8	-	5	-	-	10
SER 2100 SBS	2-3	-	-	100	-	1
SER 4100 SBS	4-5	-	-	100	-	1
SER 6100 SBS	6	-	-	100	-	1
SER 8100 SBS	8	-	-	100	-	1
SER 1050 SBS	10	-	-	50	-	1
SER 1250 SBS	12	-	-	50	-	1
SER 1450 SBS	14	-	-	50	-	1
SER 1625 SBS	16	-	-	25	-	1
SER 2025 SBS	20	-	-	25	-	1

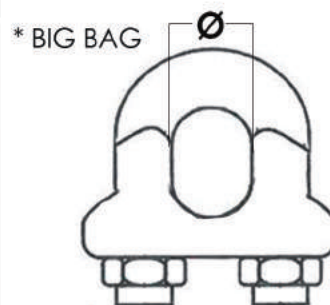

SERRE-CÂBLE ÉTRIER INOX
STAINLESS STEEL WIRE ROPE CLIP

SUJETACABLE ESTRIBO ACERO INOXIDABLE
SERRA CABO AÇO INOXIDAVEL

ROESTVRIJ STAAL KABLECLIP



Code	∅ mm		
SCI 402 NS	4-5	2	5
SCI 602 NS	6	2	5
SCI 801 NS	8	1	5
SCI 101 NP	10	1	5

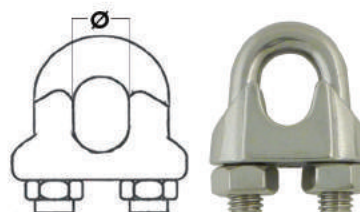



SERRE-CÂBLE ÉTRIER ACIER
STEEL WIRE ROPE CLIP

SUJETACABLE ESTRIBO ACERO
SERRA CABO AÇO

STAAL KABLECLIP



Code	Ø mm			
SERT 044 NS	4 - 5	4	-	5
SERT 062 NS	6	2	-	5
SERT 082 NS	8	2	-	5
SERT 102 NP	10	2	-	5
SERT 122 NP	12	2	-	5
SERT 141 NP	14	1	-	5
SERT 161 NP	16	1	-	5
SERT 181 NP	18	1	-	5
SERT 201 NP	20	1	-	5
SERT 4100 SBS	4 - 5	-	100	1
SERT 6100 SBS	6	-	100	1
SERT 8100 SBS	8	-	100	1
SERT 1050 SBS	10	-	50	1
SERT 1250 SBS	12	-	50	1
SERT 1450 SBS	14	-	50	1
SERT 1625 SBS	16	-	25	1
SERT 1825 SBS	18	-	25	1
SERT 2025 SBS	20	-	25	1

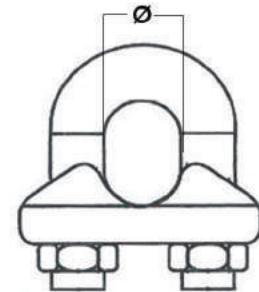

SERRE-CORDE
ROPE CLAMP

SUJETA CUERDA
ESTUFA CORDA

BROEIKAS TOUW

Code	Ø mm	L mm	l mm	l2 mm	H mm		
FER 064 NS	6-8	39	16	9	9	4	5
FER 102 NS	10-12	39	20	12	12	2	5
FER 141 NS	14	39	24	19	16	1	5

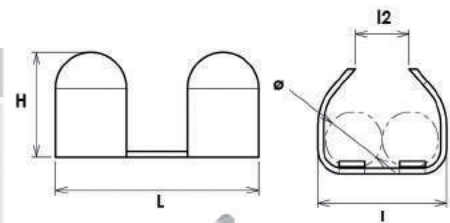

SERRE CORDON PLASTIQUE
PLASTIC TIGHTENING FOR CORDS

SUJETA CORDON PLASTICA
ESTUFA CORDAL PLASTICO

PLASTIC BROEIKAS TOUW

Code	ØA mm	ØB mm	L mm		
SCO 054 NS	4	12	26	4	5

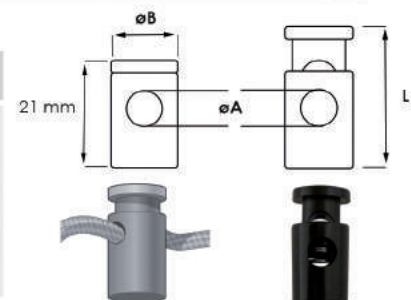



ARRÊT POUR CORDON ZAMAK NICKELÉ
NICKEL PLATED ROPE CLAMP

TOPE PARA CORDON ZAMAK NIQUELADO
ACORDAO PARA CORDA ZAMAK NIQUELADO

ARREST VOOR TOUW VERNIKELED ZAM

Code	L mm		
APC 702 NS	70	2	5

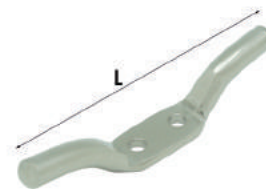

TAQUET D'AMARRAGE POLYAMIDE
POLYAMIDE CLEAT

CORNAMUSA DE AMARRE POLIAMIDA
CUNHA PARA AMARRAÇÃO POLIAMIDA

POLYAMIDE LIGPLAATS KLAMP

Code	L mm		
TAP 082 NS	80	2	5

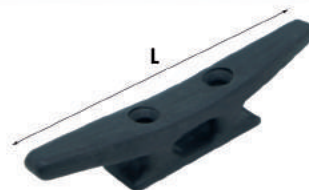

TAQUET COINÇEUR INOX
STAINLESS STEEL LATCH STUCK

TACO DE ACERO INOXIDABLE
TRAVA COLADA DE AÇO INOXIDAVEL

ROESTVRIJ STAAL KLAMP

Code	∅ mm		
CB 102 NP	1 → 6	2	5
CB 201 NP	2 → 14	1	5

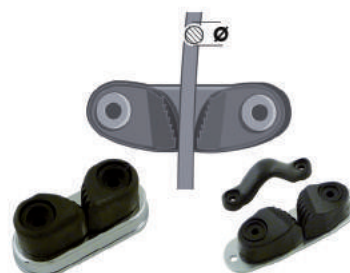

TENDEUR À CAGE
STEEL TURNBUCKLE

TENSOR DE CABLE ACERO
ESTICADOR DE CABO DE AÇO

STAAL SPANSCHROEF

Code	∅ mm	∅A mm						
TCC 042 NS	5	6	60	2	-	-	-	5
TCC 062 NS	6	8,5	70	2	-	-	-	5
TCC 082 NS	8	10	140	2	-	-	-	5
TCC 4 E	4	6	60	-	-	-	1	5
TCC 6 E	6	8,5	70	-	-	-	1	5
TCC 8 E	8	10	140	-	-	-	1	5
TCC 10 E	10	12	220	-	-	-	1	5
TCC 12 E	12	16	310	-	-	-	1	5
TCC 14 E	14	16	450	-	-	-	1	5
TCC 16 E	16	16,5	600	-	-	-	1	5
TCC 20 E	20	17,5	600	-	-	-	1	5
TCC 061 SB	6	8,5	70	-	1	-	-	10
TCC 450 SBS	5	6	60	-	-	50	-	1
TCC 650 SBS	6	8	70	-	-	50	-	1
TCC 850 SBS	8	10	140	-	-	50	-	1

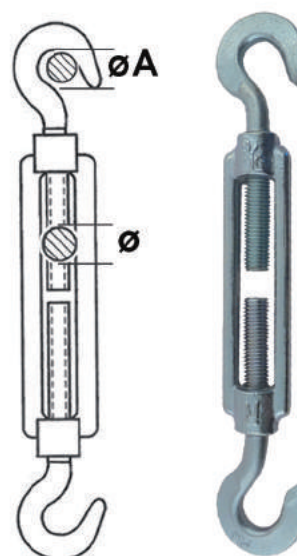



TENDEUR À CAGE INOX
STAINLESS STEEL TURNBUCKLE

TENSOR DE CABLE ACERO INOXIDABLE
ESTICADOR DE CABO DE AÇO INOXIDAVEL

ROESTVRIJ STAAL SPANSCHROEF



Code	∅ mm	KG		
TCI 6 E	6	70	1	5
TCI 8 E	8	140	1	5

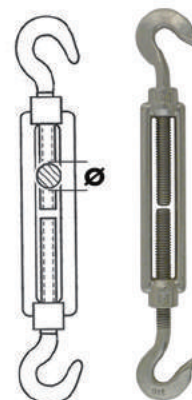

TENDEUR À CAGE
STEEL TURNBUCKLE

TENSOR DE CABLE ACERO
ESTICADOR DE CABO DE AÇO

STAAL SPANSCHROEF

Code	∅ mm	KG					
TOC 042 NS	4	60	2	-	-	-	5
TOC 062 NS	6	60	2	-	-	-	5
TOC 082 NS	8	60	2	-	-	-	5
TOC 4 E	4	60	-	-	-	1	5
TOC 6 E	6	70	-	-	-	1	5
TOC 8 E	8	140	-	-	-	1	5
TOC 10 E	10	220	-	-	-	1	5
TOC 12 E	12	310	-	-	-	1	5
TOC 14 E	14	450	-	-	-	1	5
TOC 16 E	16	600	-	-	-	1	5
TOC 042 SB	4	60	-	2	-	-	10
TOC 081 SB	8	70	-	1	-	-	10
TOC 450 SBS	4	70	-	-	50	-	1
TOC 650 SBS	6	70	-	-	50	-	1
TOC 850 SBS	8	140	-	-	50	-	1

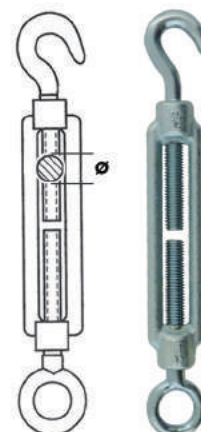

TENDEUR À CAGE INOX
STAINLESS STEEL TURNBUCKLE

TENSOR DE CABLE ACERO INOXIDABLE
ESTICADOR DE CABO DE AÇO INOXIDAVEL

ROESTVRIJ STAAL SPANSCHROEF



Code	∅ mm	KG		
TOCI 4 E	4	60	1	5
TOCI 6 E	6	70	1	5
TOCI 8 E	8	140	1	5

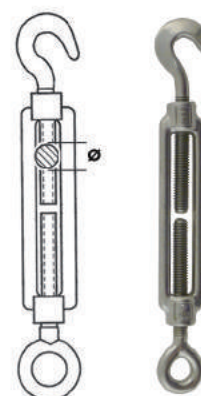



TENDEUR À CAGE
STEEL TURNBUCKLE

TENSOR DE CABLE ACERO
ESTICADOR DE CABO DE AÇO

STAAL SPANSCHROEF

Code	∅ mm	∅A mm	KG			
TOO 042 NS	5	8	60	2	-	5
TOO 062 NS	6	10	70	2	-	5
TOO 082 NS	8	11	140	2	-	5
TOO 4 E	4	8	60	-	1	5
TOO 6 E	6	8	70	-	1	5
TOO 8 E	8	11	140	-	1	5
TOO 10 E	10	14	220	-	1	5
TOO 12 E	12	17	310	-	1	5
TOO 14 E	14	18	450	-	1	5
TOO 16 E	16	23	600	-	1	5

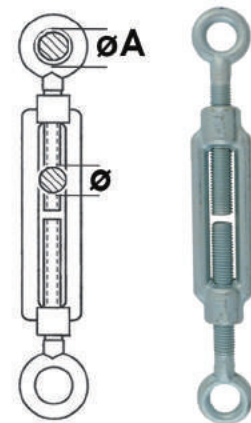

TENDEUR POUR DRISSE ALUMINIUM
ROPE TENSIONER

TENSOR ALUMINIO PARA DRIZA
TENSOR PARA CORDA

ALUMINIUM SPANNER

Code	∅ mm		
TEN 310 NS	4	10	5



TOURET DOUBLE
DOUBLE DRUMB

DOBLE TAMBOR
DUPLO TAMBOR

DUBBLE DRUM

Code	∅ mm	L mm		
DTP 221 NS	5	20	1	5
DTP 251 NS	5	25	1	5
DTP 502 NP	5	30	2	5
DTP 602 NP	6	28	2	5
DTP 052 NS*	5	13	2	5
DTP 081 NP*	8	22	1	5





TOURET BÉLIÈRE
DRUMB

TAMBOR
TAMBOR

DRUM

Code	∅ mm	L mm				
TID 551 NS	5	52	1	-	-	5
TID 651 NP	6	68	1	-	-	5
TID 5 E	5	52	-	-	1	5
TID 6 E	6	68	-	-	1	5
TID 76 E	7,6	85	-	-	1	5
TID 550 SBS	5	52	-	50	-	1
TID 650 SBS	6	68	-	50	-	1
TID 7650 SBS	7,6	85	-	50	-	1



Acier poli / Polished steel / Acero pulido / Aço polido / Beleefd staal

RAIDISSEUR POUR FIL DE TENSION
WIRE STRAINER

TENSOR PARA ALAMBRE
ESTICADOR PARA ARAME

KABEL SCHOTJE

Code					
RCB 97 E	n°2	>2mm	○	1	80
RCV 97 E/80	n°2	>2mm	●	1	80
RCV 115 E	n°3	>2,4mm	●	1	60
RCZ 97 E	n°3	>2mm	●	1	80
RCZ 115 E	n°3	>2,4mm	●	1	60
RCZ 135 E	n°4	>2,75mm	●	1	30



TENDEUR POUR CORDE À LINGE
CLOTHES LINE TENSIONER

TENSOR PARA CUERDA DE TENDER
ESTICADOR PARA ESTENDAL

WASLIJN KABEL SCHOTJE

Code	∅ mm		
TCL 30 E	3	1	30





ENROULEUR POUR VOLET ROULANT + SANGLE
ROLLER BLIND + STRAP

RECOGEDOR CON CINTA
RETRATOR COM PRECINTA

OPROLMECHANISM + RIEM

Code		L M	I mm		
EBE 141 NP		5,50	14	1	5
EBE 181 NP		5,50	18	1	5
EBG 141 NP		5,50	14	1	5
EBL 141 NP		5,50	14	1	5
EIV 141 NP		5,50	14	1	5

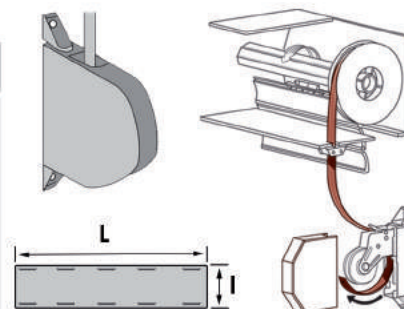

ENROULEUR SANS SANGLE
ROLLER BLIND WITHOUT STRAP

RECOGEDOR SIN CINTA
RETRATOR SEM PRECINTA

OPROLMECHANISM ZONDER RIEM

Code		L M	I mm		
EBL 221 NP		4	22	1	5
EIV 221 NP		4	22	1	5

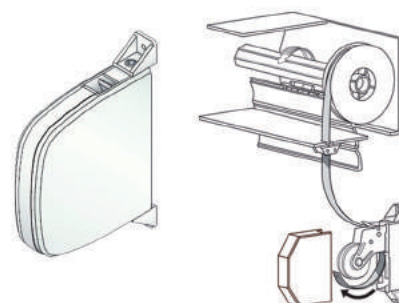

SANGLE POLYESTER POUR VOLET ROULANT
POLYESTER STRAP FOR SHUTTER

CINTA PARA RECOGEDOR
COREIA PARA PERSIANAS

POLYESTER RIEM

Code		I mm				
SVBL 146		14	6m	-	-	28
SVG 146		14	6m	-	-	28
SVR 146		14	6m	-	-	28
SVR 186		18	6m	-	-	25
SVBB 226		22	6m	-	-	20
SVBG 226		22	6m	-	-	20
SVBL 226		22	6m	-	-	20
SVBN 226		22	6m	-	-	20
SVG 226		22	6m	-	-	20
SVGB 226		22	6m	-	-	20
SVR 226		22	6m	-	-	20
SVR 159 NB		15	-	45m	1	-

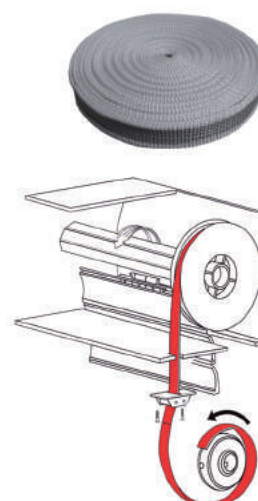



ENROULEUR ENCASTRÉ **RECOGEDOR CON PLACA** **OPROLMECHANISM**
ROLLER BLIND **RETRATOR**

Code		L M	l mm		
ENSB 40 NP		4	22	1	5
ENS 50 NP		5	22	1	5



BOUCHON D'ARRÊT **TOPE CON TORNILLO** **STOP VON ARREST**
CONICAL STOPPER **CORTICA PERSIANA**

Code		L mm		
AB 402 NP		40	2	5
ABB 402 NP		40	2	5
ABG 402 NP		40	2	5
ABL 402 NP		40	2	5
AB 602 NP		60	2	5
ABB 602 NP		60	2	5
ABG 602 NP		60	2	5
ABL 602 NP		60	2	5

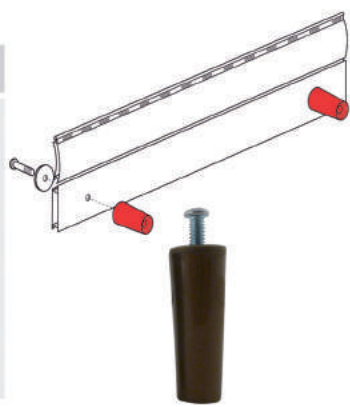

GUIDE POUR SANGLE GALET ACIER **POLEA METALICA RODILOS METALICOS** **STAAL GIDS**
STEEL GUIDE FOR STRAP **GUIA CORREIA AÇO**

Code	l mm		
GDM 221 NP	22	1	5

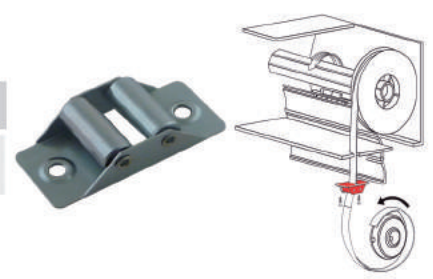

GUIDE POUR SANGLE GALET NYLON **POLEA METALICA RODILOS NYLON** **STAAL GIDS NYLON LAGER**
STEEL GUIDE FOR STRAP NYLON BEARING **GUIA CORREIA AÇO ROLAMENTO NYLON**

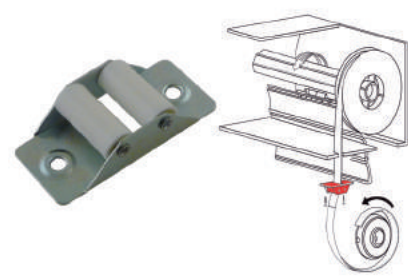

Code	l mm		
GDN 141 NP	14	1	5
GDN 221 NP	22	1	5



RESSORT POUR LAME ACIER
STEEL SPRING FOR SLAT

FLEJE PARA LAMA
TIRA PARA LAMA

STAAL VEER

Code	L mm	l mm		
RML 142 NP	140	9	2	5
RML 192 NP	190	9	2	5

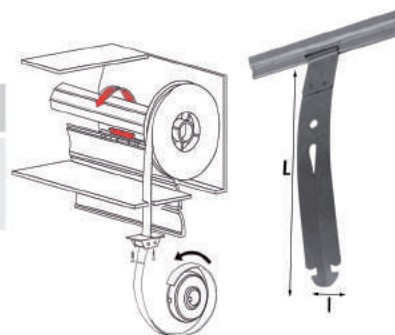

ROULEMENT À BILLE
BALL BEARING

COJINETE DE BOLA
ROLAMENTO DE ESFERA

KOGELLAGER

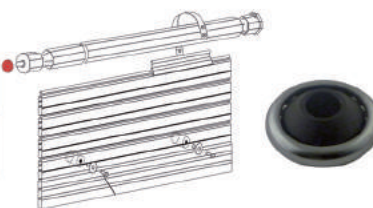

Code	Ø mm		
RNC 121 NP	42	1	5



SUPPORT + NOYAU ACIER
BRACKET + STEEL BEARING

SOPORTE + COJINETE A BOLAS METAL
APOIO + ROLAMENTO AÇO

STEUN + STAAL CIRCULATIE

Code	Ø mm		
SRM 282 NP	28	1	5

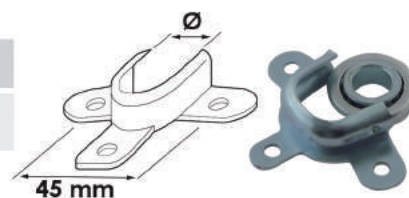

SUPPORT + NOYAU NYLON
BRACKET + NYLON BEARING

SOPORTE + COJINETE A BOLAS NYLON
APOIO + ROLAMENTO NYLON

STEUN + NYLON CIRCULATIE

Code	Ø mm		
SRN 282 NP	28	1	5

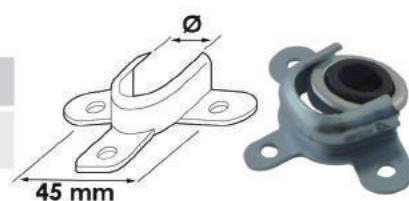



SUPPORT POUR EMBOUT
STEEL BRACKET

SOPORTE 3 OREJAS
APOIO 3 ORELHAS

STAAL STEUN

Code	l mm		
SUP 301 NP	15	1	5

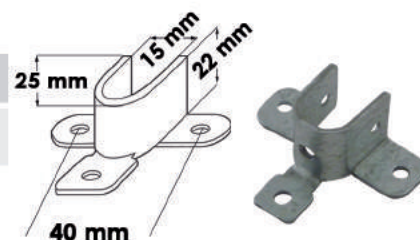

SUPPORT POUR EMBOUT
STEEL BRACKET

SOPORTE ACERO
APOIO AÇO

STAAL STEUN

Code	l mm		
SUP 401 NP	12,5	1	5

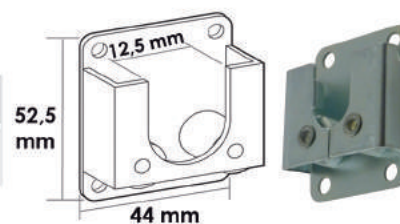

SUPPORT POUR ROULEMENT ACIER
BRACKET FOR STEEL BEARING

SOPORTE PARA COJINETE A BOLAS METAL
APOIO PARA ROLAMENTO AÇO

STEUN VOOR STAAL CIRCULATIE

Code	l mm		
SUP 501 NP	42	1	5

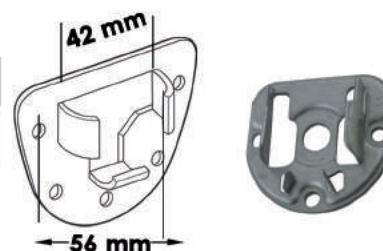

DISQUE POUR SANGLE
STRAP DISK

DISCO PARA CINTA
DISCO PARA FITA

SCHIJF VOOR RIEM

Code	ØA mm	ØB mm	l mm		
DIS 15 E	150	12	14	1	9
DIS 18 E	180	12	22	1	9

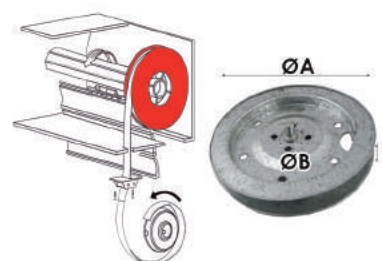



CAPSULE EN ACIER
STEEL CAPSULE

CONTERA METALICA
CAPSULA AÇO

STAAL BUS

Code	ØA mm	ØB mm		
CAS 42 E	42	10	1	27
CAS 60 E	60	12	1	27

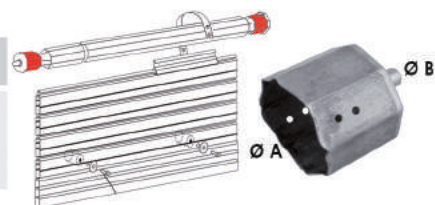

TUBE ACIER
STEEL TUBE

EJE METALICO
TUBO AÇO

STAAL BUIS

Code	Ø mm	L M	
TUR 42 E	42	2	1
TUR 60 E	60	2	1

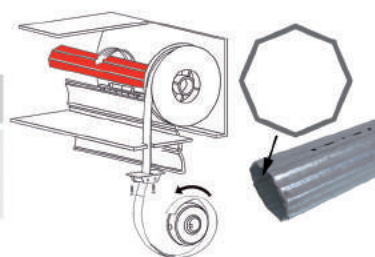

CACHE GUIDE SANGLE ALUMINIUM
ALUMINIUM HIDE GUIDE FOR STRAP

CARCASA DE ALUMINIO
ESCONDERIJO GUIA ALUMINIO

VERBERGT DE GIDS VOOR RIEM

Code		l mm		
GAB 73 NP		22	1	5
GABB 73 NP		22	1	5
GAL 73 NP		22	1	5



PLAQUE EN ALUMINIUM
ALUMINIUM PLATE

PLACA ALUMINIO
PLACA ALUMINIO

PLAAT ALUMINIUM

Code		L mm	l mm		
PABB 170 NP		170	65	1	5
PABL 170 NP		170	65	1	5
PALU 170 NP		170	65	1	5



TUYAU CRISTAL SOUPLE
FLEXIBLE CRYSTAL HOSE

MANGUERA FLEXIBLE DE CRISTAL
MANGUEIRA FLEXIVEL DE CRISTAL

KRISTAL SLANGHASPEL



Code	∅ mm		
TCS 46-180 NB	4 - 6	180m	1
TCS 69-95 NB	6 - 9	95m	1
TCS 1014-40 NB	10 - 14	40m	1

Pour / For
PB 5-6-8



TUYAU CRISTAL RENFORCÉ
STRENGTHENED CRYSTAL HOSE

MANGUERA RENFORZADA DE CRISTAL
MANGUEIRA REFORÇADA DE CRISTAL

VERSTERKT KRISTAL SLANGHASPEL

Code	∅ mm		
TCR 1016-28 NB	10 - 16	28m	1

Pour / For
PB 5-6-8



TUYAU CRISTAL AQUARIUM
AQUARIUM CRYSTAL HOSE

MANGUERA ACUARIO DE CRISTAL
MANGUEIRA AQUÁRIO DE CRISTAL

KRISTAL AQUARIUM SLANGHASPEL

Code	∅ mm		
TCA 46-180 NB	4 - 6	180m	1
TCA 811-60 NB	8 - 11	60m	1

Pour / For
PB 5-6-8



ACCESSOIRES
ACCESSORIES

ACCESORIOS
ACESSORIOS

TOEBEHOREN

Code	∅ mm			
TCD 041 NS	4	1	2	5
TCD 061 NS	6	1	2	5
TCD 081 NS	8	1	2	5
TCD 101 NS	10	1	2	5
TCL 041 NS	4	1	2	5
TCL 061 NS	6	1	2	5
TCL 081 NS	8	1	2	5
TCL 101 NS	10	1	2	5
TCT 041 NS	4	1	3	5
TCT 061 NS	6	1	3	5
TCT 081 NS	8	1	3	5
TCT 101 NS	10	1	3	5



+



TCL

+



TCT

+

